

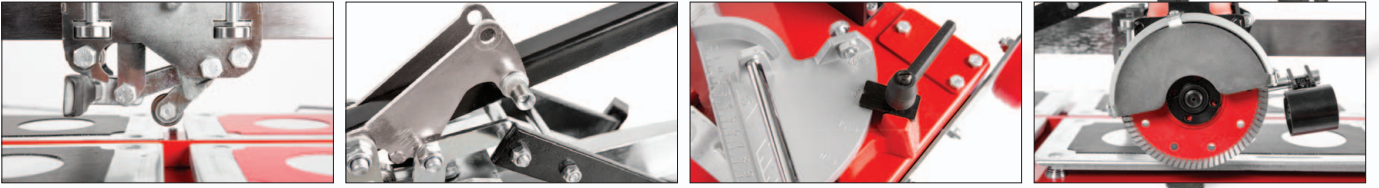

KRİSTAL®

herkül

**PROFESYONEL
SERAMİK KESME MAKİNASI**



KRİSTAL®

Masa, Kesiciler ve Kırıcılar





355 03

HERKÜL Profesyonel Seramik Kesme Makinası

Kod	Cins Kesme Boyu	Köşe Kesim	Pk/Ad.	TL/Ad.
355 00	640 mm	450x450 mm	1	15.450,00
355 01	750 mm	530x530 mm	1	16.440,00
355 02	935 mm	660x660 mm	1	18.360,00
355 03	1200 mm	840x840 mm	1	20.760,00
355 04	1350 mm	950x950 mm	1	21.930,00
355 05	1600 mm	1130x1130 mm	1	24.750,00



357 92

AYAK FARKI - 4.345,00 TL



LAZER FARKI - 2.365,00 TL

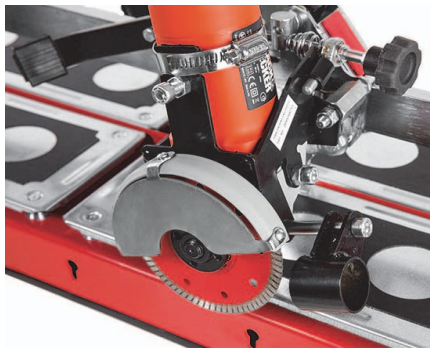

MOTOR FARKI - 8.240,00 TL



357 90

YAN TABLA - 3.745,00 TL

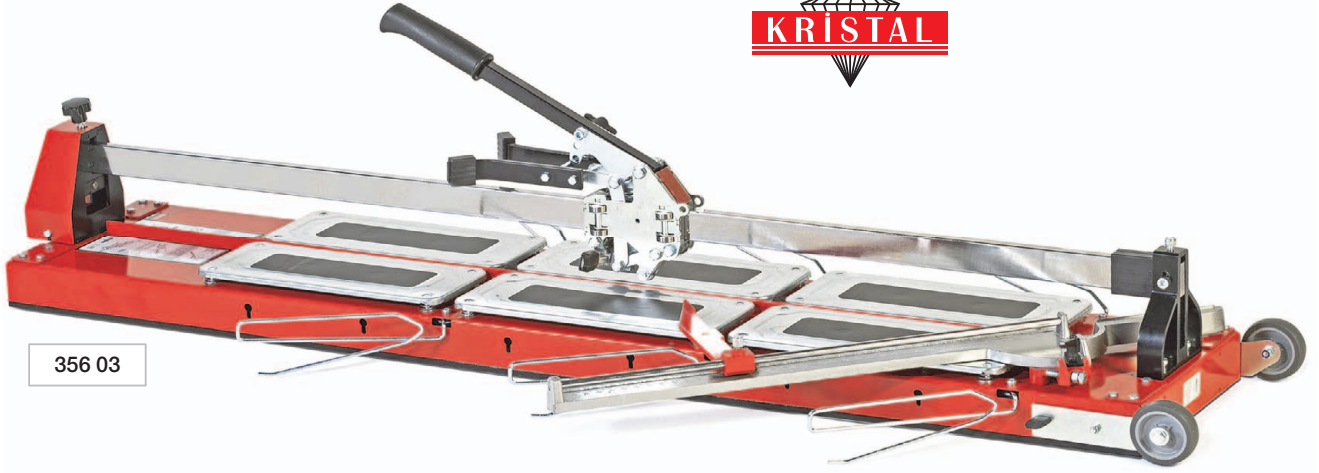
 KRİSTAL

356 03

HERKÜL

Kesme Boyu	Köşe Kesim	AYAKLI LAZERLİ		LAZERLİ		AYAKLI		HERKÜL	
		Kod	TL/Ad.	Kod	TL/Ad.	Kod	TL/Ad.	Kod	TL/Ad.
640 mm	450x450 mm	-	-	356 00	17.815,00	-	-	355 00	15.450,00
750 mm	530x530 mm	-	-	356 01	18.805,00	-	-	355 01	16.440,00
935 mm	660x660 mm	356 06	25.070,00	356 02	20.725,00	355 06	22.705,00	355 02	18.360,00
1200 mm	840x840 mm	356 07	27.470,00	356 03	23.125,00	355 07	25.105,00	355 03	20.760,00
1350 mm	950x950 mm	356 08	28.640,00	356 04	24.295,00	355 08	26.275,00	355 04	21.930,00
1600 mm	1130x1130 mm	356 09	31.460,00	356 05	27.115,00	355 09	29.095,00	355 05	24.750,00



HERKÜL MOTORLU

Kesme Boyu	Köşe Kesim	MOTORLU AYAKLI LAZERLİ		MOTORLU LAZERLİ		MOTORLU AYAKLI		MOTORLU	
		Kod	TL/Ad.	Kod	TL/Ad.	Kod	TL/Ad.	Kod	TL/Ad.
640 mm	450x450 mm	-	-	356 10	26.055,00	-	-	355 10	23.690,00
750 mm	530x530 mm	-	-	356 11	27.045,00	-	-	355 11	24.680,00
935 mm	660x660 mm	356 16	33.310,00	356 12	28.965,00	355 16	30.945,00	355 12	26.600,00
1200 mm	840x840 mm	356 17	35.710,00	356 13	31.365,00	355 17	33.345,00	355 13	29.000,00
1350 mm	950x950 mm	356 18	36.880,00	356 14	32.535,00	355 18	34.515,00	355 14	30.170,00
1600 mm	1130x1130 mm	356 19	39.700,00	356 15	35.355,00	355 19	37.335,00	355 15	32.990,00

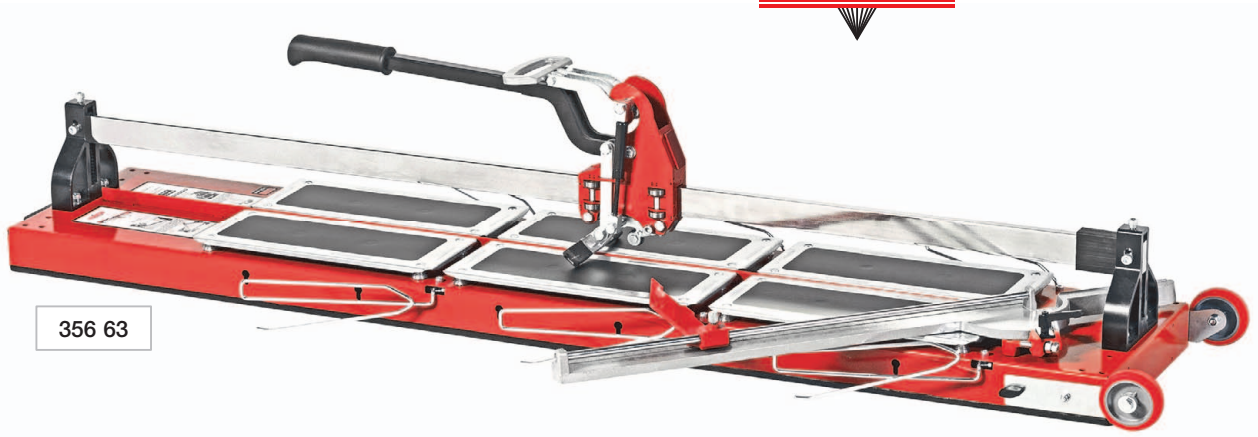

HERKÜL +EKSTRA Profesyonel Seramik Kesme Makinası

Kod	Cins Kesme Boyu	Köşe Kesim	Pk./Ad.	TL/Ad.
356 62	935 mm	660x660 mm	1	18.360 TL brüt + 2.095 TL net
356 63	1200 mm	840x840 mm	1	20.760 TL brüt + 2.095 TL net
356 64	1350 mm	950x950 mm	1	21.930 TL brüt + 2.095 TL net
356 65	1600 mm	1130x1130 mm	1	24.750 TL brüt + 2.095 TL net



MERCAN Seramik Kesme Makinası

Kod	Cins Kesme Boyu	Köşe Kesim	Pk./Ad.	TL/Ad.
355 37	700 mm	490x490 mm	1	7.310,00
355 38	850 mm	600x600 mm	1	7.790,00
355 39	1000 mm	705x705 mm	1	8.390,00



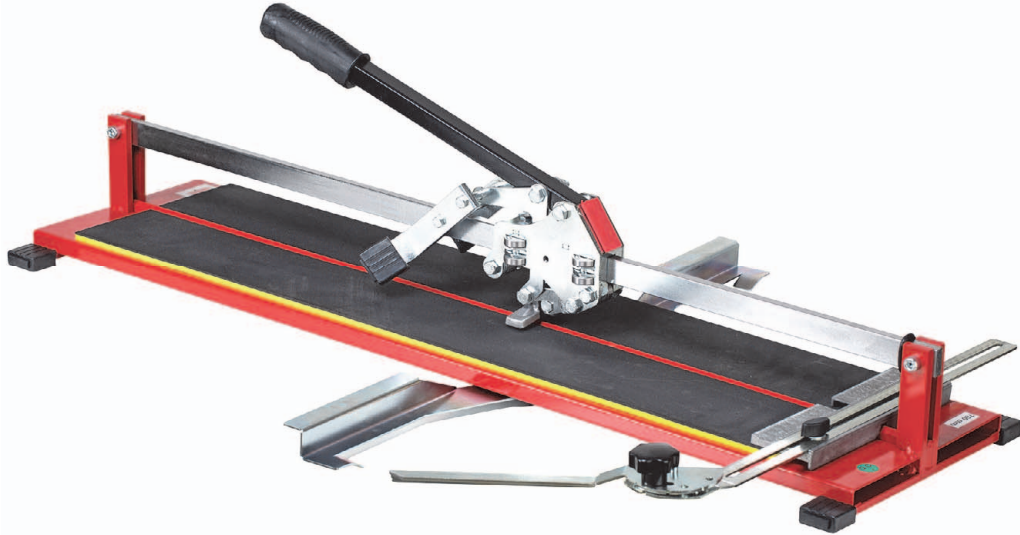

KİKLOP Profesyonel Seramik Kesme Makinası

Kod	Kesme Boyu	Köşe Kesim	Pk/Ad.	TL/Ad.
355 41	640 mm	450x450 mm	1	11.250,00
355 36	750 mm	530x530 mm	1	11.700,00
355 42	935 mm	660x660 mm	1	13.140,00
355 43	1200 mm	840x840 mm	1	14.250,00

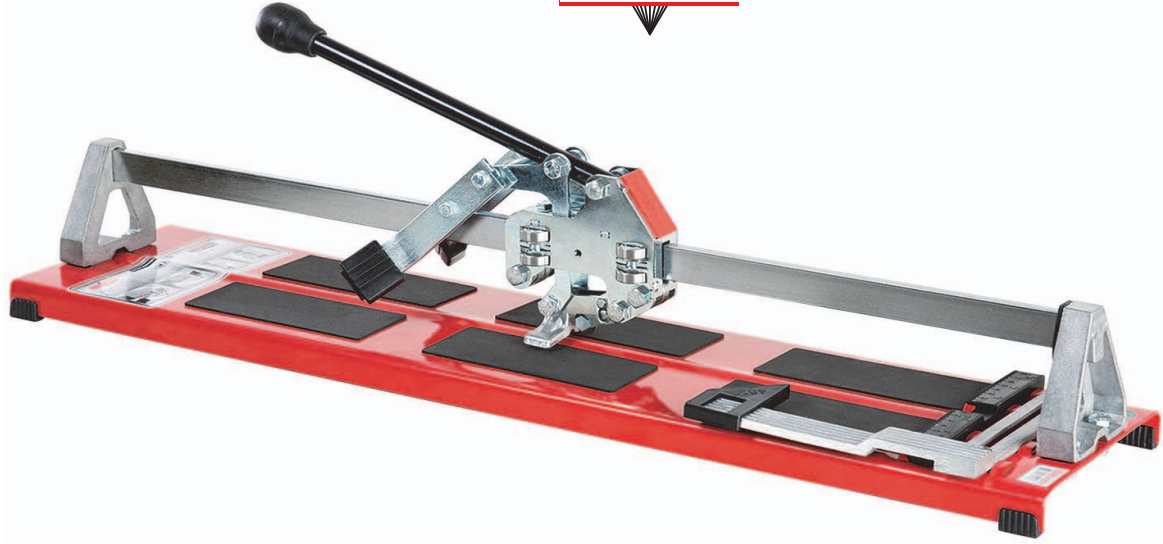

YAKUT Seramik Kesme Makinası

Cins Kesme Boyu	Köşe Kesim	Pk/Ad.	YAKUT LAZERLİ		YAKUT	
			Kod	TL/Ad.	Kod	TL/Ad.
700 mm	490x490 mm	1	356 56	9.595,00	355 56	8.100,00
850 mm	600x600 mm	1	356 57	10.135,00	355 57	8.640,00
1000 mm	705x705 mm	1	356 58	10.645,00	355 58	9.150,00



SUPERLETO Seramik Kesme Makinası

Cins Kesme Boyu	Köşe Kesim	Pk/Ad.	SUPERLETO LAZERLİ		SUPERLETO	
			Kod	TL/Ad.	Kod	TL/Ad.
600 mm	420x420 mm	4	356 20	5.165,00	355 20	3.970,00
850 mm	600x600 mm	3	356 21	5.585,00	355 21	4.390,00
1000 mm	705x705 mm	3	356 22	5.720,00	355 22	4.525,00



LETO Seramik Kesme Makinası

Cins Kesme Boyu	Köşe Kesim	Pk/Ad.	LETO LAZERLİ		LETO	
			Kod	TL/Ad.	Kod	TL/Ad.
470 mm	330x330 mm	4	356 25	3.765,00	355 25	2.685,00
600 mm	420x420 mm	4	356 26	3.955,00	355 26	2.875,00
850 mm	600x600 mm	3	356 27	4.465,00	355 27	3.385,00
1000 mm	705x705 mm	3	356 28	4.580,00	355 28	3.500,00



KLASİK Seramik Kesme Makinası

Kod	Kesme Boyu	Köşe Kesim	Pk./Ad.	TL/Ad.
355 33	470 mm	330x330 mm	4	2.410,00
355 34	600 mm	430x430 mm	4	2.590,00



ARES Seramik Kesme Makinası

Kod	Kesme Boyu	Köşe Kesim	Pk./Ad.	TL/Ad.
355 32	600 mm	420x420 mm	4	2.410,00



ZEUGMA Mozaik Kesme Makinası

Kod	Kesme Boyu	Köşe Kesim	Pk./Ad.	TL/Ad.
355 55	470 mm	330x330 mm	1	6.100,00



ZÜMRÜT Seramik Kesme Makinası

Cins Kesme Boyu	Köşe Kesim	Pk/Ad.	ZÜMRÜT LAZERLİ		ZÜMRÜT	
			Kod	TL/Ad.	Kod	TL/Ad.
700 mm	490x490 mm	1	356 80	9.885,00	355 80	8.390,00
850 mm	600x600 mm	1	356 81	10.785,00	355 81	9.290,00
1000 mm	705x705 mm	1	356 82	11.455,00	355 82	9.960,00



SUPERSAFİR Seramik Kesme Makinası

Cins Kesme Boyu	Köşe Kesim	Pk/Ad.	SUPERSAFİR LAZERLİ		SUPERSAFİR	
			Kod	TL/Ad.	Kod	TL/Ad.
600 mm	420x420 mm	4	356 50	6.650,00	355 50	5.570,00
850 mm	600x600 mm	3	356 51	7.580,00	355 51	6.500,00
1000 mm	705x705 mm	3	356 52	7.980,00	355 52	6.900,00



TOPAZ Büyük Ebatlı Seramik Kesme Makinası

Kod	Model	Özellikler	TL/Ad.
355 85	Topaz 3m	1ad. Manuel Kesici / 2ad. Alm.Gövde / 4ad. Vantuz / 1ad. Kırıcı Pense	19.000,00
355 87	Motor Aparatı	1ad. Motorlu Kesici 45° - 90° / 2ad. Seramik Tutma Aparatı / 1ad. 45° Gönye	7.790,00
355 85C	Çanta	Topaz Taşıma Çantası	1.040,00
345 46	Topaz 360cm	1ad. Manuel Kesici / 3ad. Alm.Gövde / 5ad. Vantuz / 1ad. Kırıcı Pense	21.570,00



PRO Büyük Ebatlı Seramik Kesme Makinası

Kod	Kesme Boyu	Köşe Kesim	Özellik	Pk./Ad.	TL/Ad.
356 70	1850 mm	1305 x 1305 mm	4 tablalı	1	41.650,00
355 84	2000 mm	1410 x 1410 mm	4 tablalı	1	43.450,00
355 83	2600 mm	1835 x 1835 mm	6 tablalı	1	45.250,00



Vantuzlu Taşıma Aparatı

Kod	Cins	Özellik	Pk./Ad.	TL/Ad.
355 95	Vantuzlu Taşıma Aparatı	200 x 88 cm / 8 ad. Vantuz	1	16.330,00
355 96	Vantuzlu Taşıma Aparatı Arabası - Küçük	35595, 34550 ve 34551 ile kullanılır	1	11.230,00
355 97	Seramik Taşıma Arabası - Büyük	4 tekerlekli	1	21.870,00



Vantuzlu Taşıma Aparatları

Kod	Cins	Pk./Ad.	TL/Ad.
345 50	Ayarlı Taşıma Aparatı (2-3,6 m) , (6 Pompalı Vantuzlu)	1	34.500,00
345 51	Ayarlı Taşıma Aparatı (2-3,6 m) , (2 Pompalı Vantuz + 6 Normal Vantuz)	1	27.000,00
345 60	Tek Sıra Ayarlı Taşıma Aparatı, 3 Pompalı Vantuzlu (2-3,6 m)	1	13.500,00
345 61	Tek Sıra Ayarlı Taşıma Aparatı, 3 Normal Vantuzlu (2-3,6 m)	1	8.250,00
345 64	Aparatlı Pompalı Vantuz (yedek, 34550, 34560 için)	1	3.120,00
345 65	Aparatlı Pompalı Vantuz (yedek, 34551 için)	1	3.180,00
345 66	Aparatlı Normal Vantuz (yedek)	1	570,00
345 67	Bağlantı Elemanı (yedek)	1	270,00
345 68	Emniyet Ayakları Seti (yedek)	1	630,00
345 69	Taşıma Tekerleri Seti (yedek)	1	1.100,00

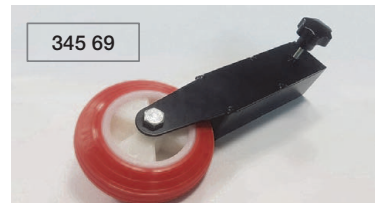
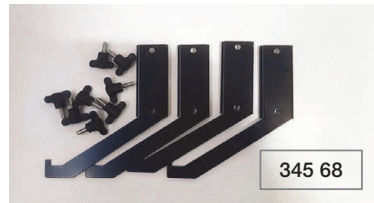
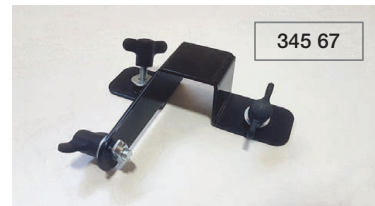
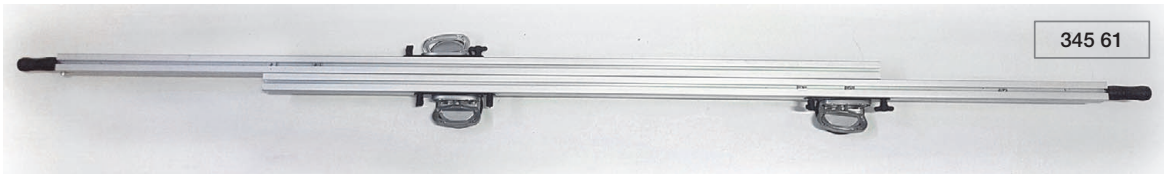
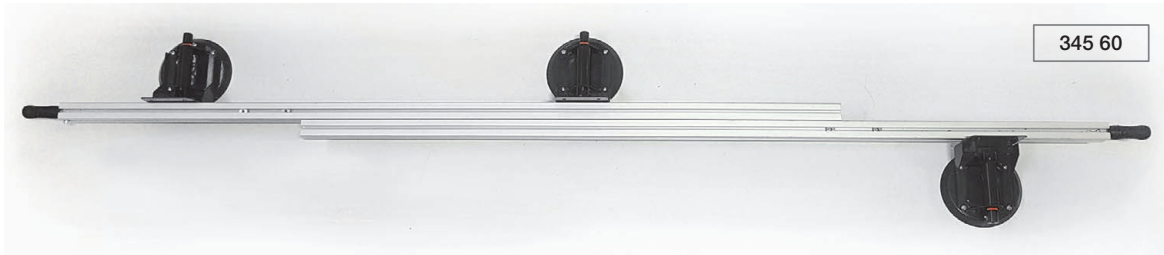



Seramik İşleme Masası

Kod	Özellik	Pk/Ad.	TL/Ad.
355 60	100 x 200 cm Seramik İşleme Masası, Sıkıştırma Mengeneli (2.masa eklenecek 100x400 cm boyutlarına büyütülebilmektedir)	1	12.400,00
355 59	İlave 100 cm Uzatma Aparatı (35560 Seramik İşleme Masası için)	1	6.000,00
355 63	İlave 69 cm Genişletme Aparatı (35560 Seramik İşleme Masası için)	1	6.000,00



TİTAN 45° Pah Kesme Makinası

Kod	Kesme Boyu	Köşe Kesim	Pk/Ad.	TL/Ad.
355 48	1200 mm	840x840 mm	1	26.500,00
355 49	1600 mm	1100x1100 mm	1	29.700,00



Motorlu Harç Karıştırıcı

Kod	Özellik	Pk./Ad.	TL/Ad.
334 81	2 ad. 30 lt. Kovalı	1	27.000,00

Seramik Kesme Makinası - Yedek Elmasları

	Kod	Cinsi	Pk/Ad.	TL/Ad.
klasik	355 70	KLASİK - SKM Elmas Takımı	1 Tk.	131,00
kiklop	355 71	KİKLOP - SKM Elmas Takımı	1 Tk.	123,00
leto	355 72	LETO - SKM Elmas Takımı	1 Tk.	
superleto	355 73	SuperLETO & SuperSAFİR - SKM Elmas Takımı	1 Tk.	
herkül yakut	355 74T	120° 7-10 mm Sert Seramikler için TİTANYUM kaplı	1 Tk.	425,00
	355 74	120° 7-10 mm Seramikler için	1 Tk.	284,00
	355 75	110° 11-20 mm Seramikler için	1 Tk.	
	355 76	130° 3-6 mm Seramikler için	1 Tk.	

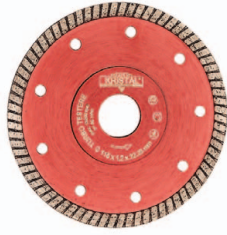

Elmas Turbo Testere

Kod	Cins	Pk./Ad.	USD/Ad.
334 50	Ø 115 Elmas Turbo Testere	1	12,85 \$
334 51	Ø 180 Elmas Turbo Testere	1	28,55 \$
334 52	Ø 230 Elmas Turbo Testere	1	35,70 \$

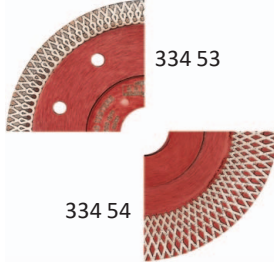

MESH Elmas Testere

Kod	Cins	Pk./Ad.	USD/Ad.
334 53	Ø 115 Mesh Elmas Testere	1	14,25 \$
334 54	Ø 115 Mesh Ekstra Pah Açma Elmas Testere	1	18,00 \$



Porselen Delici Uçlar (sulu delme)

Kod	Ölçü (mm)	Pk./Ad.	USD/Ad.
333 75	Ø 6	1	4,30 \$
333 76	Ø 8	1	4,40 \$
333 77	Ø 10	1	4,50 \$
333 78	Ø 12	1	4,90 \$
333 79	Ø 20	1	7,50 \$
333 80	Ø 32	1	12,00 \$
333 81	Ø 42	1	16,60 \$
333 82	Ø 55	1	19,00 \$
333 83	Ø 65	1	25,50 \$
333 84	Ø 75	1	26,00 \$
333 85	Ø 85	1	29,00 \$
333 88	Vantuzlu Delik Kılavuzu (Ø 6,8,10,12,...,95)	1	445,00 ₺
333 89	Delici Uç Kılavuzu (Ø 6,8,10,12,20,32,42)	1	8,10 ₺
333 90	Özel Sünger (porsadrill)	1	1,00 \$



333 88



333 90



Delici Uçlar - M14 (kuru delme)

Kod	Cins	Pk./Ad.	USD/Ad.
333 28	Ø 6 mm / M14 Dişi	1	7,55 \$
333 29	Ø 8 mm / M14 Dişi	1	7,55 \$
333 30	Ø 10 mm / M14 Dişi	1	7,55 \$
333 31	Ø 12 mm / M14 Dişi	1	7,55 \$
333 32	Ø 16 mm / M14 Dişi	1	8,10 \$
333 34	Ø 20 mm / M14 Dişi	1	10,30 \$
333 33	Ø 22 mm / M14 Dişi	1	10,70 \$
333 35	Ø 25 mm / M14 Dişi	1	11,00 \$
333 36	Ø 35 mm / M14 Dişi	1	16,00 \$
333 43	Ø 38 mm / M14 Dişi	1	17,00 \$
333 37	Ø 40 mm / M14 Dişi	1	18,00 \$
333 38	Ø 45 mm / M14 Dişi	1	20,70 \$
333 42	Ø 50 mm / M14 Dişi	1	23,00 \$
333 39	Ø 55 mm / M14 Dişi	1	25,00 \$
333 41	Ø 60 mm / M14 Dişi	1	27,00 \$
333 40	Ø 65 mm / M14 Dişi	1	32,00 \$

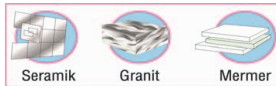



SERAMİK İŞLEME ELEMANLARI

Delici Setler

Kod	Cinsi	Set Malzemeleri	Euro/Ad.
333 00	6 Parçalı Set (Kutulu)	Ø33 - Ø53 - Ø67 - Ø73 Dairesel Tutucu Merkezeleme Matkap Ucu (Ø 9)	23,00 €
Max: 1500 rpm			



Aralık Tarağı

Kod	Cinsi	Euro/Ad.
333 11	Aralık Tarağı (Küçük) 145 mm	2,70 €
333 12	Aralık Tarağı (Büyük) 205 mm	3,70 €
333 13	Yedek Bıçağı - (Küçük) 30 mm	0,60 €
333 14	Yedek Bıçağı - (Büyük) 50 mm	0,80 €



333 09

333 10

Delici Set Yedekleri

Kod	Ölçü (mm)	Euro/Ad.
333 03	Ø 33	3,15 €
333 04	Ø 43	3,80 €
333 05	Ø 53	4,60 €
333 06	Ø 67	5,60 €
333 07	Ø 73	6,00 €
333 08	Ø 83	6,80 €
333 09	Dairesel Tutucu Ø 83	3,90 €
333 10	Merkezeleme Matkap Ucu Ø 9	2,80 €



Akıllı Soğutucu

Kod	Ölçü (mm)	Euro/Ad.
333 19	Akıllı Soğutucu	15,15 €



OK Tipi Matkap Ucu

Kod	Cins	USD/Ad.
333 70	Ø 6	1,75 \$
333 69	Ø 7	2,55 \$
333 71	Ø 8	2,70 \$
333 72	Ø 10	2,94 \$
333 73	Ø 12	3,50 \$

Seramik, Mermer, Plastik, Ahşap



Matkap Ucu

Kod	Ölçü (mm)	Euro/Ad.
333 51	Ø 4 x 80	1,85 €
333 52	Ø 5 x 90	2,35 €
333 53	Ø 6 x 100	3,05 €
333 54	Ø 7 x 110	3,45 €
333 55	Ø 8 x 120	3,80 €
333 57	Ø 10 x 140	5,60 €
333 58	Ø 12 x 160	7,00 €

Beton, Tuğla, Çelik, Cam, Seramik, Ahşap



Titreşimli Vantuzlu Tokmak (DC16V 5A 2000mAh)

Kod	Cins	Pk/Ad.	USD/Ad.
334 41	Tit. Van. Tokmak - Çantalı, 2 Bataryalı	1	160,00 \$
334 42	16V 2.0AH Yedek Batarya	1	36,90 \$

Çok Amaçlı Titreşim Makinası Aksesuarları

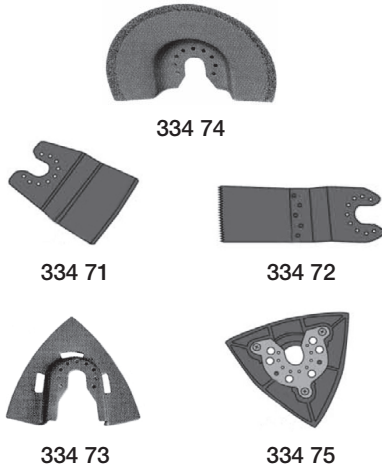

Kod	Cins	Pk/Ad.	USD/Ad.
334 71	50 mm Kazıma Ucu	1	2,25 \$
334 72	34 mm Kesme Ucu	1	2,45 \$
334 73	78 mm Karbürlü Fayans Çim. Temizleyici	1	5,55 \$
334 74	92 mm Elmas Derz Temizleyici	1	8,40 \$
334 75	80 mm Zımparalama Aparatı	1	3,15 \$
334 76	Zımpara Seti	1	1,50 \$
334 77	Adaptör (Bosch, Dremel)	1	1,60 \$
334 78	Adaptör (Fein, Rockwell)	1	3,60 \$



334 90



334 91



334 92

Cam Mozaik Kesme Aletleri



334 93

Kod	Cinsi	Pk/Ad.	Euro/Ad.
334 90	Çift Bıçaklı Kerpeten (C)	1	20,00 €
334 91	Kerpeten (B)	1	24,00 €
334 92	Tek Bıçaklı Kırıcılı Kerpeten (A)	1	12,00 €
334 93	Çelik Ağızlı Kerpeten (papağan)	1	12,50 €

Seramik Kaldırma Aparatı



Kod	Uygulanabilecek Ölçü	Pk/Ad.	TL/Ad.
355 98	60x60x2 cm	1	1.335,00



Profesyonel Vantuz



334 68



334 69

Kod	Cinsi	Pk./Ad.	USD/Ad.
334 65	Tekli Ø115 / 50Kg. Kaldırma Kap.	1	9,00 \$
334 66	Çiftli Ø115 / 100Kg. Kaldırma Kap.	1	15,50 \$
334 67	Üçlü Ø115 / 150Kg. Kaldırma Kap.	1	25,00 \$
334 68	Pompalı Vantuz / 100Kg. Kaldırma Kap.	1	40,00 \$
334 69	Pompalı Vantuz - Metal Saplı, Pls.Çantalı	1	60,00 \$
350 57	20 Kg. Kaldırma Kapasitesi	1	11,00 TL

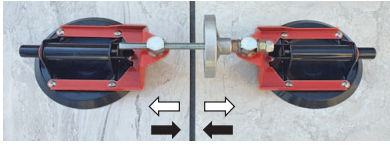

Seramik Çektirme

Kod	Cinsi	Pk./Ad.	TL/Ad.
334 60	Seramik Çektirme	1	4.455,00



Poliüretan Dizlik

Kod	Cinsi	Pk./Ad.	Fiyat/Çift
334 48	Poliüretan Dizlik	20	12,00 €



Kauçuk Tokmak

Kod	Cinsi	Pk./Ad.	USD/Ad. *
334 45	500 gr - Beyaz & Ahşap Saplı	36	4,90 \$
334 46	750 gr - Beyaz & Ahşap Saplı	24	6,10 \$
334 47	1000 gr - Beyaz & Ahşap Saplı	24	7,50 \$



Dizlikli Tekerlekli Araba

Kod	Cinsi	Pk./Ad.	TL/Ad.
355 99	Dizlikli Tekerlekli Araba	1	2.739,00

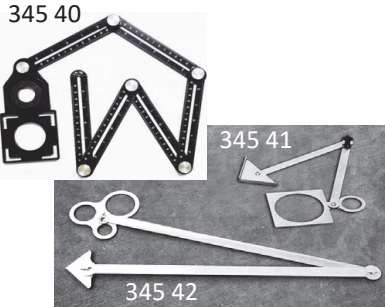

Fayans Markörü

Kod	Delik Çapları	Pk./Ad.	TL/Ad.
345 41	KÜÇÜK (35mm ve 85mm)	6	151,00
345 42	BÜYÜK (35mm, 52mm, 70mm)	2	310,00
345 40	Alüminyum Delik Markörü	1	7,20 \$



355 89

355 90

Ağır Yük Seramik Kırma Aparatı

Kod	Kırma Kalınlığı	Pk./Ad.	TL/Ad.
355 89	Küçük , 3 - 12 mm	1	945,00
355 90	Büyük , 6 - 20 mm	1	1.134,00



Pratik Seramik Taşıma Aparatı

Kod	Uygulanabilecek Kalınlık	Pk./Ad.	TL/Ad.
355 91	5 - 15 mm	4	810,00



Akıllı Takoz

Kod	Cinsi	Kova/Ad.	TL/Kova
335 10	Akıllı Takoz , Plastik Kovalı	24	253,80

SERAMİK TESVİYE SİSTEMİ

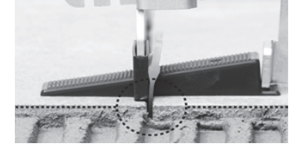
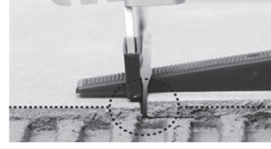

Seramik Tesviye Pensesi

Kod	Cinsi	Pk./Ad.	TL/Ad.
335 00	"Kama-Klips" Sıkıştırma Pensesi	6	318,60



Kama

Kod	Cinsi	Pk./Ad.	TL/Pk.
335 05	Kama	100	128,25

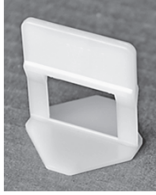

335 01



335 04

Klips

(1 Pk = 250 Ad.)

(1 Pk = 200 Ad.)

Cinsi	Seramik Kalınlığı	Kod	TL/Pk.	Kod	TL/Pk.
1 mm	3-12 mm	335 01	141,75	335 21	116,10
1,5 mm	3-12 mm	335 06	141,75	335 20	116,10
2 mm	3-12 mm	335 02	141,75	335 22	116,10
3 mm	3-12 mm	335 03	141,75	335 23	116,10
4 mm	3-12 mm	335 07	141,75	335 24	116,10
5 mm	3-12 mm	335 08	141,75	335 25	116,10
1,5 mm Uzun	12-20 mm	335 04	151,20	-	-



1500 ad.
33 lt beyaz kovalı



1000 ad.
20 lt siyah kovalı

Klips - Kovalı

(1 Kova = 1500 Ad.)

(1 Kova = 1000 Ad.)

Cinsi	Seramik Kalınlığı	Kod	TL/Kova	Kod	TL/Kova
1 mm	3-12 mm	335 32	1.053,00	335 14	648,00
1,5 mm	3-12 mm	335 33	1.053,00	335 15	648,00
2 mm	3-12 mm	335 34	1.053,00	335 16	648,00
3 mm	3-12 mm	335 35	1.053,00	335 17	648,00
4 mm	3-12 mm	335 36	1.053,00	335 18	648,00
5 mm	3-12 mm	335 37	1.053,00	335 19	648,00

Klips - Çuvalı

Kod	Cinsi	Seramik Kalınlığı	Çuval/Ad.	TL/Çuval
335 26	1 mm	3-12 mm	4.000	2.241,00
335 27	1,5 mm	3-12 mm	4.000	2.241,00
335 28	2 mm	3-12 mm	4.000	2.241,00
335 29	3 mm	3-12 mm	4.000	2.241,00
335 30	4 mm	3-12 mm	4.000	2.241,00
335 31	5 mm	3-12 mm	4.000	2.241,00





Sulu Kesim Makinaları



ZOE

Kod	Cinsi Kesme Boyu	Testere Çapı	Beygir Gücü	Max.Kesme Kalınlığı	Ağırlık	Euro/Ad.
R420105A P	105 cm	300 - 360 mm	3	120 mm	84 kg.	3.550 €
R420130A P	130 cm	300 - 360 mm	3	120 mm	98 kg.	3.840 €
R420150A P	150 cm	300 - 360 mm	3	120 mm	106 kg.	4.240 €

Ø 300 mm, Porselen için testere ile beraber gelmektedir.



SMS

Kod	Cinsi Kesme Boyu	Testere Çapı	Beygir Gücü	Max.Kesme Kalınlığı	Ağırlık	Euro/Ad.
R223MS 125EUP	125 cm	300 - 350 mm	3	100 mm	85 kg.	3.420 €
R223MS 150EUP	150 cm	300 - 350 mm	3	100 mm	98 kg.	3.770 €
R223MS 200EU	220 cm	300 - 350 mm	3	90 mm	120 kg.	4.880 €

Ø 300 mm, Porselen için testere ile beraber gelmektedir.



MISTRAL

Kod	Cinsi Kesme Boyu	Testere Çapı	Beygir Gücü	Max.Kesme Kalınlığı	Ağırlık	Euro/Ad.
R224MS 90EU	90 cm	300 - 350 mm	3	100 mm	60 kg.	2.450 €
R224MS 120EU	120 cm	300 - 350 mm	3	100 mm	65 kg.	2.690 €
R224MS 150EU	150 cm	300 - 350 mm	3	100 mm	69 kg.	2.920 €

Ø 300 mm, Porselen için testere ile beraber gelmektedir.



BOLT

Kod	Cinsi Kesme Boyu	Testere Çapı	Beygir Gücü	Max.Kesme Kalınlığı	Ağırlık	Euro/Ad.
R225MS 90EU	90 cm	250 mm	1,5	55 mm	46 kg.	2.060 €
R225MS 120EU	120 cm	250 mm	1,5	55 mm	50 kg.	2.260 €
R225MS 150EU	150 cm	250 mm	1,5	55 mm	56 kg.	2.550 €

Ø 250 mm, Porselen için testere ile beraber gelmektedir.



EXPLOIT

Kod	Cinsi Kesme Boyu	Testere Çapı	Beygir Gücü	Max.Kesme Kalınlığı	Ağırlık	Euro/Ad.
R392N	70 cm	180 mm	0,9	45 mm	42 kg.	1.560 €
R393N 090EU	90 cm	200 mm	0,9	45 mm	35 kg.	1.720 €

Seramik için testere ile beraber gelmektedir.

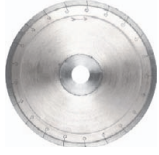

ELMAS TESTERELER

Kod	Testere Çapı	Cins	Pk./Ad.	Euro/Ad.
R179SET300BE	300 mm	Porselen için, Segmentli Testere	1	220 €



R299C500

299RAICUT

KANAL AÇMA MAKİNASI

Kod	Cins	Pk./Ad.	Euro/Ad.
R299RAICUT	RAI-CUT (0-30mm kalınlık), 850W taş. dahil	1	435 €
R299C500	RAI-FIX paslanmaz kanca , 8mm	500	1,90 €

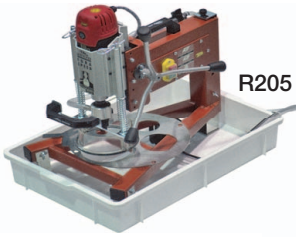

R205

DELİM MAKİNASI

Kod	Cins	Pk./Ad.	Euro/Ad.
R205	FORASPEED (4-120mm) 1,5HP	1	1.700 €
R210	FORACOSTE (Yatay delim) (4-12mm) 1,5HP	1	1.850 €



R210



R212



R214



R213VEL



R248N

FUGA MAKİNASI

Kod	Cins	Pk./Ad.	Euro/Ad.
R219	MAXITITINA 1,2 HP	1	1.880 €
R212	Derz doldurucu disk	1	330 €
R2728	Yedek kağuçuk seti (8 li)	1	170 €
R214	Düzleştirici çelik disk	1	185 €
R213VELCRO	Disk tutucu (keçe/velkro)	1	145 €
R248N	Siyah keçe disk (yüksek aşındırma)	5	18 €



R219



R34

VİBRATÖR MAKİNASI

Kod	Cins	Pk./Ad.	Euro/Ad.
R349	MASTINO , 3 devirli , 49x56cm taban, 250W	1	3.050 €

ŞARJLI VİBRATÖR MAKİNASI

Kod	Cins	Pk./Ad.	Euro/Ad.
R321BATPRR	E-FOX , 24x41cm taban, 38.5 Wh, çantalı	1	720 €



e-fox

R399ADV



TEMİZLEYİCİ SÜNGER MAKİNASI

Kod	Cins	Pk./Ad.	Euro/Ad.
R399ADV	BERTA , (havana sünger dahil) 120W	1	2.400 €

Dİ-STAR ELMAS TESTERELER

AVANTAJLARI	 <p>kuru kesim</p>	1A1R DECOR SLIM (dekoratif)
Kuru kesim için uygundur. Temiz, rahat ve çapaksız kesim yapar.		UYGULAMA ALANI
Kod	Ürün Ölçüleri (mm)	Euro / Ad.
111 154 27 009	115 x1,2x8x22,23	21,00

AVANTAJLARI	 <p>kuru kesim</p>	1A1R GRES MASTER (süratli)
Özellikle hızlı ve kuru kesim yapılması için tasarlanmıştır. Granit, Mermer, Porselen görünümlü çok sert seramikler ve doğal taşlar için uygundur.		UYGULAMA ALANI
Kod	Ürün Ölçüleri (mm)	Euro / Ad.
111 151 60 009	115 x1,4x10x22,23	23,50

AVANTAJLARI	 <p>kuru kesim</p>	1A1R ESTHETE (estetik)
Çok hassas, dekoratif seramikler için uygundur. 1,1mm kalınlığındaki ultra ince elmas tabakası en hassas işler için tasarlanmıştır. Ortasındaki flanş sayesinde esneme ve titreşim minimuma indirilmiştir.		UYGULAMA ALANI
Kod	Ürün Ölçüleri (mm)	Euro / Ad.
111 154 21 009	115 x1,1x8x22,23	33,50

Dİ-STAR ELMAS TESTERELER

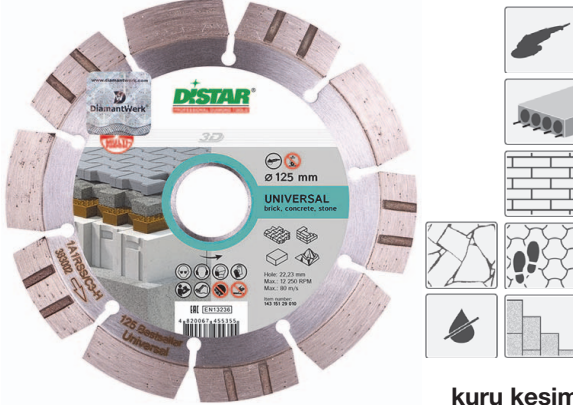
AVANTAJLARI	 <p>kuru kesim</p>	1A1RSS/C3 UNIVERSAL (çok amaçlı)
Ekonomik üründür. Farklı malzemeler için kullanıma uygundur.		UYGULAMA ALANI
Kod	Ürün Ölçüleri (mm)	Euro / Ad.
143 151 29 009	115 x2.2x10x22,23	15,00
143 151 29 014	180 x2.2x10x22,23	25,00

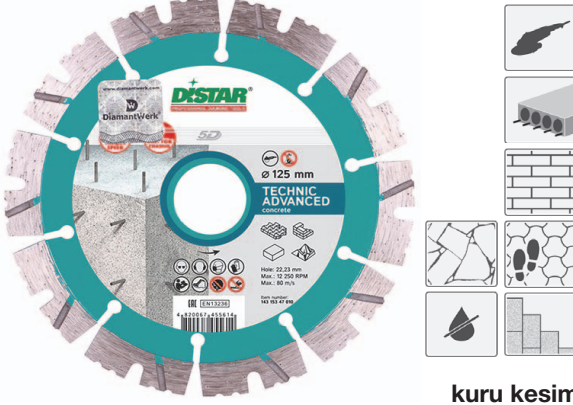
AVANTAJLARI	 <p>kuru kesim</p>	1A1RSS/C3 TECHNIC ADVANCED (ileri teknik)
Bina inşaatlarında kullanılan malzemelerin neredeyse tümünü (doğal taş dahil) hızlı bir biçimde kesmek mümkündür. Duvarda ve yerde kanal açmak için en uygun üründür.		UYGULAMA ALANI
Kod	Ürün Ölçüleri (mm)	Euro / Ad.
143 153 47 009	115 x2,2x10x22,23	17,00
143 153 47 014	180 x2,6x12x22,23	29,00

AVANTAJLARI	 <p>kuru kesim</p>	1A1RSS STONE (taş)
Tüm doğal malzemeler ile çalışmaya uygun ekonomik ürün. Genel kullanım için uygundur. Dengeli, sabit kesim hızı.		UYGULAMA ALANI
Kod	Ürün Ölçüleri (mm)	Euro / Ad.
143 150 84 009	115 x2,2x8x22,23	15,00
143 150 84 014	180 x2,6x8x22,23	25,00

Dİ-STAR ELMAS TESTERELER

<p>AVANTAJLARI</p> <p>Tüm granit tiplerini hızlı kesmek için tasarlanmıştır. Soğutma kanalları sayesinde sürekli kesime ve ağır çalışma şartlarına uygundur. 180mm testeredeki flanş sayesinde esneme ve titreşim minimuma indirilmiştir.</p>	 <p>Ö 115 mm Elite granite, sandstone</p> <p>Art.: 101 150 23 009 4 820067 454990</p> <p>kuru kesim</p>	<p>TURBO ELITE (seçkin)</p> <p>UYGULAMA ALANI</p> <p>Granit, Mermer, Doğal Taş,</p>
<p>Kod</p>	<p>Ürün Ölçüleri (mm)</p>	<p>Euro / Ad.</p>
<p>101 150 23 009</p>	<p>115 x2,2x8x22,23</p>	<p>16,50</p>
<p>101 150 24 014</p>	<p>180 x1,4x8,5x22,23</p>	<p>34,50</p>

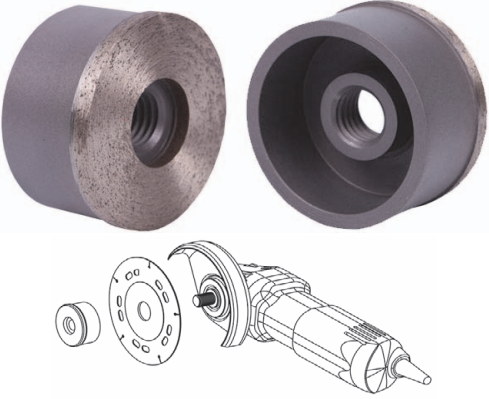
		<p>DGW-S / M14 HARD CERAMIC (sert seramik)</p> <p>UYGULAMA ALANI</p> <p>Fayans, Seramik, Mermer,</p>
<p>Kod</p>	<p>Ürün Ölçüleri</p>	<p>Euro / Ad.</p>
<p>174 835 22 216</p>	<p>49mm / M14</p>	<p>30,50</p>

Dİ-STAR ELMAS TESTERELER

AVANTAJLARI	 <p>sulu kesim</p>	1A1R HARD CERAMICS (sert seramik)
Çok kaliteli, çapaksız kesim. Tüm seramik ve mermer çeşitleri için uygundur. Uzun ömürlüdür. Birim maliyeti düşüktür.		UYGULAMA ALANI
		Sırlı Seramik, Mermer, Kuvarsit,
Kod	Ürün Ölçüleri (mm)	Euro / Ad.
111 200 48 015	200 x1,6x10 x25,4	34,50
111 200 48 019	250 x1,6x10 x25,4	44,00
111 270 48 022	300 x2x10 x32/25,4	73,50
111 270 48 024	350 x2,2x10 x32/25,4	94,00

AVANTAJLARI	 <p>sulu kesim</p>	1A1R HARD CERAMICS ADVANCED (sert seramik ileri)
Kalın (20mm ve üzeri) porselen seramikler için mükemmel çözüm. Ultra ince testere kalınlığı, çapaksız ve kusursuz kesim yapmanızı sağlar.		UYGULAMA ALANI
		Çok Sert, Kalın Seramik ve Türevleri
Kod	Ürün Ölçüleri (mm)	Euro / Ad.
111 203 49 015	200 x1,3x10 x25,4	40,50
111 205 28 017	230 x1,5x10 x25,4	46,50
111 203 49 019	250 x1,5x10 x25,4	52,00
111 205 28 022	300 x1,8x10 x25,4	82,00

AVANTAJLARI	 <p>sulu kesim</p>	1A1R EDGE (kenar)
Hatasız 45° kenarlar. Kusursuz pah kesim. Mükemmel çapaksız kesim. 25mm elmas genişliği.		UYGULAMA ALANI
		Seramik, Mermer, Granit,
Kod	Ürün Ölçüleri (mm)	Euro / Ad.
111 204 21 015	200 x1,4x25 x25,4	81,00
111 204 21 019	250 x1,4x25 x25,4	105,00



Dİ-STAR ELMAS TESTERELER

AVANTAJLARI Doğal taş, porselen, granit, ve mermer kesmek için uygundur. Hızlı kesim ve çok amaçlı kullanım için tasarlanmıştır.	  sulu kesim	1A1R GRANITE PREMIUM (granit)
Kod		UYGULAMA ALANI Granit, Mermer (tüm tipler),
Kod 113 270 61 022	Ürün Ölçüleri (mm) 300 x2,4x10 x32/25,4	Euro / Ad. 62,00

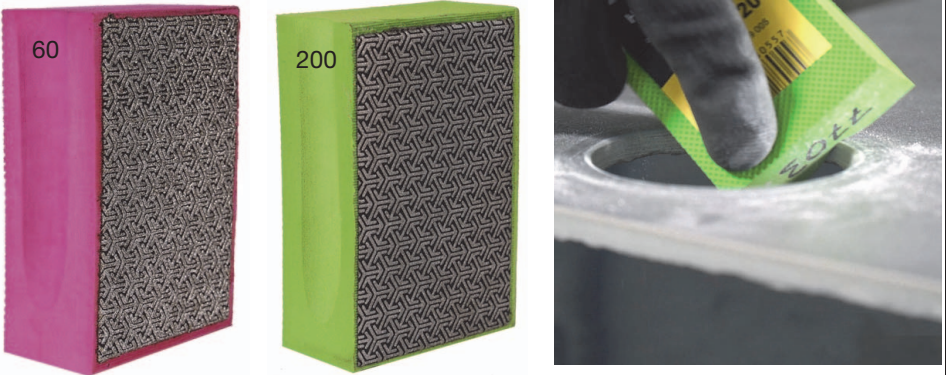
AVANTAJLARI Uzun ömürlü, temiz ve çapaksız kesim.	  sulu kesim	1A1R MARBLE (mermer)
Kod		UYGULAMA ALANI Kireç taşı, Mermer (tüm tipler), Traverten,
Kod 111 270 53 022	Ürün Ölçüleri (mm) 300 x2x10 x32/25,4	Euro / Ad. 60,00

AVANTAJLARI Porselen ve doğal taş için manuel el zımparası		
Kod	Ürün Ölçüleri (mm)	Euro / Ad.
910 637 557 005	Elmas Ped 60 kum - Pembe	23,00
910 637 559 005	Elmas Ped 200 kum - Yeşil	23,00

BAUMESSER ELMAS TESTERELER

		 <p>kuru kesim</p>	<p>1A1R KERAMİK (seramik)</p>
			<p>UYGULAMA ALANI</p> <p>Seramik, Fayans, Traverten,</p>
Kod	Ürün Ölçüleri (mm)	Euro / Ad.	
913 150 95 009	115 x1,4x8x22,23	11,10	
913 150 95 010	125 x1,4x8x22,23	11,80	
913 204 81 014	180 x1,6x8,5x22,23	16,80	
913 204 81 017	230 x2,0x8,5x22,23	25,00	



		 <p>kuru kesim</p>	<p>TURBO CERAMICS ULTRA (seramik)</p>
			<p>UYGULAMA ALANI</p> <p>Seramik, Fayans, Traverten,</p>
Kod	Ürün Ölçüleri (mm)	Euro / Ad.	
013 155 41 009	115 x1,4x8x22,23	7,40	

		 <p>kuru kesim</p>	<p>TURBO UNIVERSAL (çok amaçlı)</p>
			<p>UYGULAMA ALANI</p> <p>Beton, Tuğla, Seramik,</p>
Kod	Ürün Ölçüleri (mm)	Euro / Ad.	
902 151 29 017	230 x2,3x9x22,23	16,30	

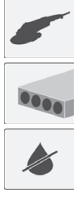

ELMAS TESTERELER

		DGS-S BETON MAX (beton)
		UYGULAMA ALANI
		Beton
Kod	Ürün Ölçüleri (mm)	Euro / Ad.
970 150 07 005	100 / 22,23	25,00
970 150 07 010	125 / 22,23	29,00

kuru kesim

		1A1RSS BETON (beton)
		UYGULAMA ALANI
		Beton, Kaldırım Taşı, Hafif Donatılı Beton, Hazır Beton, Betopan,
Kod	Ürün Ölçüleri (mm)	Euro / Ad.
101 700 85 389	350 x3,5x10x25,4 (11,5-21 HIT)	79,00
101 700 85 425	400 x3,5x10x25,4 (11,5-24 HIT)	94,50
101 700 85 152	450 x4,0x10x25,4 (11,5-26 HIT)	131,00

sulu kesim

		1A1RSS ASPHALT (asfalt)
		UYGULAMA ALANI
		Asfalt
Kod	Ürün Ölçüleri (mm)	Euro / Ad.
101 700 85 105	350 x3,5x10x25,4 (11,5-24 HIT)	100,00
101 700 85 108	400 x3,5x10x25,4 (11,5-28 HIT)	121,00
101 700 85 106	450 x4,0x10x25,4 (11,5-32 HIT)	164,00

sulu kesim

MECHANIC TOZ TOPLAMA APARATLARI

AirDUSTER	
 <p>Ürünün aerodinamik tasarımı sayesinde kesici diski soğutur, diskin ömrünü uzatır ve kesim hızını artırır. Sıradan bir elektrikli süpürge kullanarak kapalı alanlarda rahatlıkla çalışabilirsiniz. Ürünün tasarımından dolayı oluşan kuvvetli hava akımı, elektrikli süpürge kullanmadan bile tozun büyük kısmını basit bir hortum ile dışarı atabilmenizi sağlar ve iş veriminizi artırır.</p>	
Kod	Ürün Ölçüleri (mm)
195 684 42 013	AirDuster (115-125)
Euro / Ad.	
24,00	

AirCHASER	
 <p>Duvarda ve yerde açılan kablo kanalları genelde elmas testerelerle özel kanal açma makinesi kullanılarak yapılır. Kanal açma işlerindeki en mantıklı çözüm avuç içi taşlama makinelerinde kullanılan AirCHASER aparatıdır. Standart kanal açma makinelerine kıyasla hafiftir, ucuzdur, toz toplar ve elmas testerenin soğumasına yardımcı olur.</p>	
Kod	Ürün Ölçüleri (mm)
195 684 42 224	AirChaser (115-125)
Euro / Ad.	
54,00	

SLIDER 45	
 <p>Seramik ve doğal taş döşeme işlerinde 45 derecelik pah açma işi her geçen daha fazla talep edilen ve popüler hale gelen bir uygulama olmuştur. Pah açılarak yapılan köşe birleştirmeler standart uygulamalara göre çok daha estetik durmaktadır. Bu tür uygulamalar çok hassas işçilik ve üst düzey kesim kalitesi gerektirmektedir. SLIDER 45 aparatı ile sulu kesim makinaya ihtiyaç duymadan, çok daha hızlı, pratik ve ucuza aynı işi yapabilirsiniz. Tozların yayılmasını engellemek için PIPE45 kullanılmalıdır.</p>	
Kod	Ürün Ölçüleri (mm)
195 684 42 113	Slider45 (115-125)
195 684 42 114	Toz Toplama Ünitesi (PIPE 45)
Euro / Ad.	
51,00	
11,50	

Yedek Parça listesine
buradan ulaşabilirsiniz.



<https://www.kristal-ltd.com/yedekler>

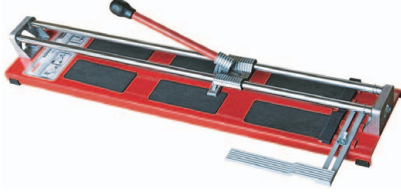

KLASİK Seramik Kesme Makinası



LETO Seramik Kesme Makinası



SuperLETO Seramik Kesme Makinası



Yakut Seramik Kesme Makinası

Seramik Kesme Makinası - Yedek Parçaları

Kod	Cinsi	TL/Ad.
357 00	Elmas Pimi (Klasik & Leto)	5,10
357 01	Klasik Alüminyum Takoz	120,00
357 02	Klasik Alüminyum Kılavuzlu	81,00
357 03	Klasik Kılavuzlu Pimi	7,50
357 04	Klasik Alüminyum Raybalı	90,00
357 05	Klasik Alm. Küçük Kırıcı	58,50
357 06	Alm. Gönye (Klasik -Leto -Ares -SuperLETO)	99,00
357 07	Dereceli Gönye (Klasik -Leto -Ares -SuperLETO)	52,50
357 08	Klasik Sap (Kılavuzlu)	150,00
357 09	KLASİK Komple Kol	600,00
357 11	Klasik Kesme Boru - 470 mm	180,00
357 12	Klasik Kesme Boru - 600 mm	210,00
357 13	Klasik Kesme Boru - 850 mm	240,00
357 20	Komple Alüminyum Kol (Leto & Ares)	810,00
357 21	Alüminyum Takoz (Leto & Ares & SuperLETO)	120,00
357 22	Lama - 470 mm (Leto & Ares & SuperLETO)	450,00
357 23	Lama - 600 mm (Leto & Ares & SuperLETO)	555,00
357 24	Lama - 850 mm (Leto & Ares & SuperLETO)	705,00
357 25	Lama - 1000 mm (Leto & Ares & SuperLETO)	780,00
357 35	Kırıcı Ayak Takımı (Leto & Ares)	159,00
357 15	Alüminyum Dayama Gönyesi (SafirRulmanlı)	285,00
357 16	Açılı Çelik Gönye Takımı (SafirRulmanlı)	558,00
357 17	Elmas Tutucu Gövde (SuperLETO)	384,00
357 18	Elmas Cıvata Pimi (SuperLETO)	33,00
357 19	SuperLETO Komple Kol	2.100,00
357 30	Pls. Gönye 45° (SuperLETO & Leto & Ares)	27,00
357 31	Alm. Kırıcı (SuperLETO & Yakut & Mercan)	93,00
357 36	Kırıcı Ayak Takımı (SuperLETO)	171,00
357 79	Komple Kol (Yakut & Mercan)	3.300,00
357 78	Açılı Çelik Gönye Takımı (Yakut & Mercan)	720,00
357 77	Alüminyum Dayama Gönyesi (Yakut & Mercan)	480,00
357 76	Elmas Tutucu Gövde (Yakut & Mercan)	375,00
357 74	Yakut Lama 700 mm (Yakut & Mercan)	840,00
357 73	Yakut Lama 850 mm (Yakut & Mercan)	960,00
357 72	Yakut Lama 1000 mm (Yakut & Mercan)	1.080,00
357 37	Kırıcı Ayak Takımı (Yakut & Mercan)	201,00

Yedek Parça listesine buradan ulaşabilirsiniz.



<https://www.kristal-ltd.com/yedekler>

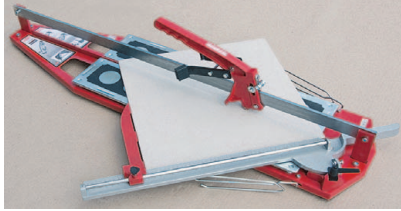

Açılı Seramik Kesme-Kiklop



Açılı Seramik Kesme-Herkül



355 64



357 97

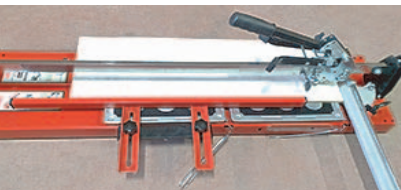

358 00

Kiklop & Herkül SKM - Yedek Parçaları

Kod	Cinsi	TL/Ad.
357 40	Elmas Cıvata Pimi - Kiklop	15,00
357 41	Elmas Burcu - Kiklop	18,00
357 42	Komple Gönye (Kiklop & Herkül)	2.640,00
357 43	Kiklop Komple Kol	3.750,00
357 44	Kol Yayı - Kiklop	18,00
357 45	Lama Tutucu (Takoz) - Kiklop	306,00
357 46	Sustalı Kol (Kiklop & Herkül)	189,00
357 47	Gönye Tutucu Laması (Kiklop & Herkül)	30,00
357 51	Alm. Gönye Altı (Kiklop & Herkül)	345,00
357 52	Kol Burcu - Kiklop	27,00
357 53	608 Rulman	54,00
357 54	Delikli Pim - Kiklop	48,00
357 56	Kiklop Lama - 640 mm	1.230,00
357 57	Kiklop Lama - 935 mm	1.920,00
357 58	Kiklop Lama - 1200 mm	2.100,00
357 65	Tabla Sacı (Vidalı) (Kiklop & Herkül)	315,00
357 66	Destek Teli Takımı (Kiklop & Herkül)	258,00
357 38	Kırcı Ayak Takımı (Kiklop)	306,00
357 80	HERKÜL Komple Kol	5.250,00
357 82	HERKÜL Alm. Büyük Kırcı	300,00
357 83	Elmas Cıvata Pimi (Herkül & Yakut)	39,00
357 84	Lama Tutucu Takoz 2'li (Herkül)	1.500,00
357 85	Elmas Tutucu Gövde (Herkül)	735,00
355 64	Paralellik Klavuzu - 250 mm	324,00
357 86	Herkül Lama - 640 mm	2.700,00
357 87	Herkül Lama - 750 mm	3.000,00
357 88	Herkül Lama - 935 mm	3.600,00
357 89	Herkül Lama - 1200 mm	4.200,00
357 98	Herkül Lama - 1350 mm	4.650,00
357 99	Herkül Lama - 1600 mm	5.400,00
357 93	Herkül Mafsallı Ayak Burcu	180,00
357 95	Herkül Taşıma Teker Takımı	639,00
357 96	Herkül Çekme Sap Takımı	90,00
357 39	Kırcı Ayak Takımı (Herkül)	381,00
357 68	Kol Amortisörü (Herkül Ekstra & PRO-2600)	210,00
357 97	Herkül Arka Dayama Gönyesi	615,00
358 00	Herkül Seri Kesim Dayama Aparatı	1.002,00

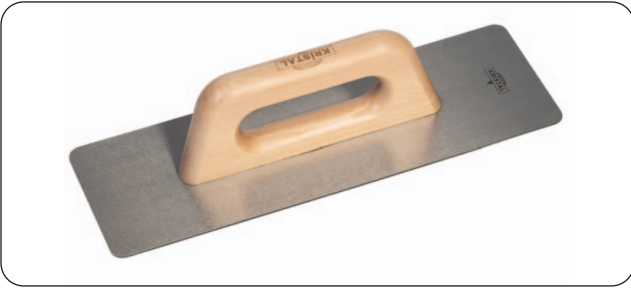
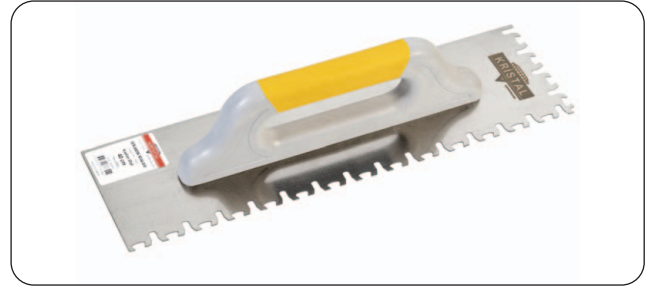
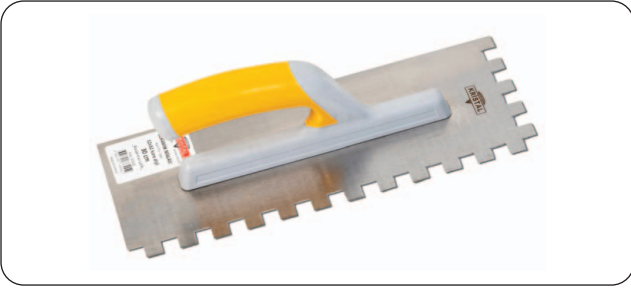

Seramik-Sıva-Boya El Aletleri

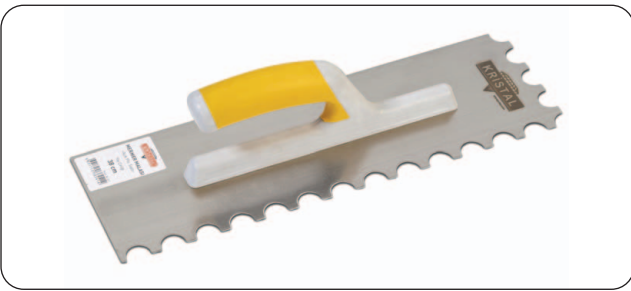

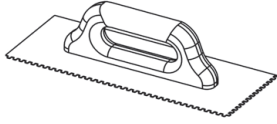
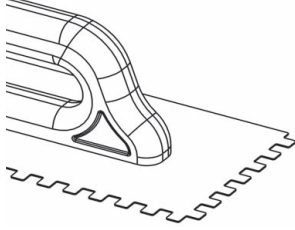

SERAMİK MALASI (Kare Dişli)

Özellik	Ölçü	Ad./Koli	Paslanmaz Çelik		Yay Çeliği	
			Kod	Fiyat/Ad.	Kod	Fiyat/Ad.
Plastik Kapalı Saplı	30 cm	12	36 500	130,00 ₺	36 100	102,00 ₺
	35 cm	12	36 501	137,30 ₺	36 101	104,20 ₺
4 x 4 Diş	40 cm	12	36 502	156,00 ₺	36 102	119,00 ₺
	50 cm	12	36 503	195,00 ₺	36 103	142,00 ₺
Ahşap Kapalı Saplı	30 cm	12	36 570	161,70 ₺	36 170	120,30 ₺
	35 cm	12	36 571	169,70 ₺	36 171	128,00 ₺
4 x 4 Diş	40 cm	12	36 572	207,80 ₺	36 172	160,20 ₺
	50 cm	12	36 573	254,30 ₺	36 173	188,80 ₺



Plastik Kapalı Saplı	30 cm	12	36 505	130,00 ₺	36 105	102,00 ₺
	35 cm	12	36 506	137,30 ₺	36 106	104,20 ₺
6 x 6 Diş	40 cm	12	36 507	156,00 ₺	36 107	119,00 ₺
	50 cm	12	36 508	195,00 ₺	36 108	142,00 ₺
Ahşap Kapalı Saplı	30 cm	12	36 575	161,70 ₺	36 175	120,30 ₺
	35 cm	12	36 576	169,70 ₺	36 176	128,00 ₺
6 x 6 Diş	40 cm	12	36 577	207,80 ₺	36 177	160,20 ₺
	50 cm	12	36 578	254,30 ₺	36 178	188,80 ₺



Plastik Kapalı Saplı	30 cm	12	36 510	130,00 ₺	36 110	102,00 ₺
	35 cm	12	36 511	137,30 ₺	36 111	104,20 ₺
8 x 8 Diş	40 cm	12	36 512	156,00 ₺	36 112	119,00 ₺
	50 cm	12	36 513	195,00 ₺	36 113	142,00 ₺
Ahşap Kapalı Saplı	30 cm	12	36 580	161,70 ₺	36 180	120,30 ₺
	35 cm	12	36 581	169,70 ₺	36 181	128,00 ₺
8 x 8 Diş	40 cm	12	36 582	207,80 ₺	36 182	160,20 ₺
	50 cm	12	36 583	254,30 ₺	36 183	188,80 ₺

Fiyatlarımız NET' tir.

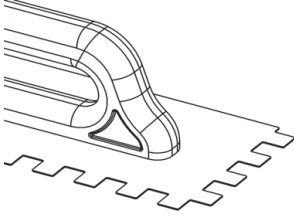
**SERAMİK MALASI (Kare Dişli)**

Özellik	Ölçü	Ad./Koli	Paslanmaz Çelik		Yay Çeliği	
			Kod	Fiyat/Ad.	Kod	Fiyat/Ad.
Plastik Kapalı Saplı 10 x 10 Diş	30 cm	12	36 515	130,00 ₺	36 115	102,00 ₺
	35 cm	12	36 516	137,30 ₺	36 116	104,20 ₺
	40 cm	12	36 517	156,00 ₺	36 117	119,00 ₺
	50 cm	12	36 518	195,00 ₺	36 118	142,00 ₺
Ahşap Kapalı Saplı 10 x 10 Diş	30 cm	12	36 585	161,70 ₺	36 185	120,30 ₺
	35 cm	12	36 586	169,70 ₺	36 186	128,00 ₺
	40 cm	12	36 587	207,80 ₺	36 187	160,20 ₺
	50 cm	12	36 588	254,30 ₺	36 188	188,80 ₺

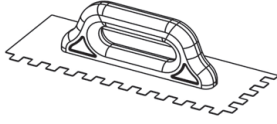

Plastik Kapalı Saplı 12 x 12 Diş	30 cm	12	36 520	130,00 ₺	36 120	102,00 ₺
	35 cm	12	36 521	137,30 ₺	36 121	104,20 ₺
	40 cm	12	36 522	156,00 ₺	36 122	119,00 ₺
	50 cm	12	36 523	195,00 ₺	36 123	142,00 ₺
Ahşap Kapalı Saplı 12 x 12 Diş	30 cm	12	36 590	161,70 ₺	36 190	120,30 ₺
	35 cm	12	36 591	169,70 ₺	36 191	128,00 ₺
	40 cm	12	36 592	207,80 ₺	36 192	160,20 ₺
	50 cm	12	36 593	254,30 ₺	36 193	188,80 ₺

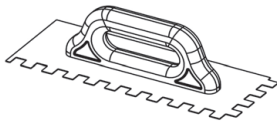

Plastik Kapalı Saplı 14 x 14 Diş	30 cm	12	36 525	130,00 ₺	36 125	102,00 ₺
	35 cm	12	36 526	137,30 ₺	36 126	104,20 ₺
	40 cm	12	36 527	156,00 ₺	36 127	119,00 ₺
	50 cm	12	36 528	195,00 ₺	36 128	142,00 ₺
Ahşap Kapalı Saplı 14 x 14 Diş	30 cm	12	36 595	161,70 ₺	36 195	120,30 ₺
	35 cm	12	36 596	169,70 ₺	36 196	128,00 ₺
	40 cm	12	36 597	207,80 ₺	36 197	160,20 ₺
	50 cm	12	36 598	254,30 ₺	36 198	188,80 ₺

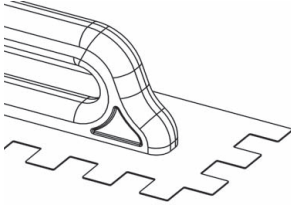
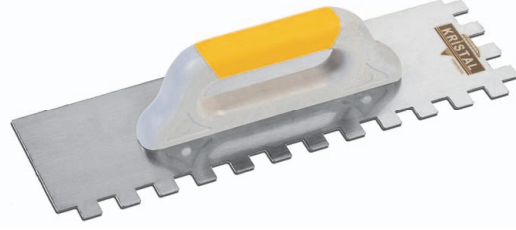

SERAMİK MALASI (Kare Dişli)

Özellik	Ölçü	Ad./Koli	Paslanmaz Çelik		Yay Çeliği	
			Kod	Fiyat/Ad.	Kod	Fiyat/Ad.
Plastik Kapalı Saplı 16 x 16 Diş	30 cm	12	36 530	130,00 ₺	36 130	102,00 ₺
	35 cm	12	36 531	137,30 ₺	36 131	104,20 ₺
	40 cm	12	36 532	156,00 ₺	36 132	119,00 ₺
	50 cm	12	36 533	195,00 ₺	36 133	142,00 ₺
Ahşap Kapalı Saplı 16 x 16 Diş	30 cm	12	36 600	161,70 ₺	36 200	120,30 ₺
	35 cm	12	36 601	169,70 ₺	36 201	128,00 ₺
	40 cm	12	36 602	207,80 ₺	36 202	160,20 ₺
	50 cm	12	36 603	254,30 ₺	36 203	188,80 ₺

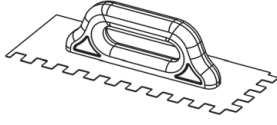

Plastik Kapalı Saplı 18 x 18 Diş	30 cm	12	36 750	130,00 ₺	36 350	102,00 ₺
	35 cm	12	36 751	137,30 ₺	36 351	104,20 ₺
	40 cm	12	36 752	156,00 ₺	36 352	119,00 ₺
	50 cm	12	36 753	195,00 ₺	36 353	142,00 ₺
Ahşap Kapalı Saplı 18 x 18 Diş	30 cm	12	36 770	161,70 ₺	36 370	120,30 ₺
	35 cm	12	36 771	169,70 ₺	36 371	128,00 ₺
	40 cm	12	36 772	207,80 ₺	36 372	160,20 ₺
	50 cm	12	36 773	254,30 ₺	36 373	188,80 ₺



Plastik Kapalı Saplı 20 x 20 Diş	30 cm	12	36 755	130,00 ₺	36 355	102,00 ₺
	35 cm	12	36 756	137,30 ₺	36 356	104,20 ₺
	40 cm	12	36 757	156,00 ₺	36 357	119,00 ₺
	50 cm	12	36 758	195,00 ₺	36 358	142,00 ₺
Ahşap Kapalı Saplı 20 x 20 Diş	30 cm	12	36 775	161,70 ₺	36 375	120,30 ₺
	35 cm	12	36 776	169,70 ₺	36 376	128,00 ₺
	40 cm	12	36 777	207,80 ₺	36 377	160,20 ₺
	50 cm	12	36 778	254,30 ₺	36 378	188,80 ₺

Fiyatlarımız NET' tir.

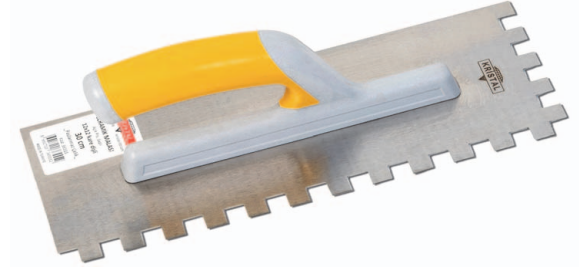
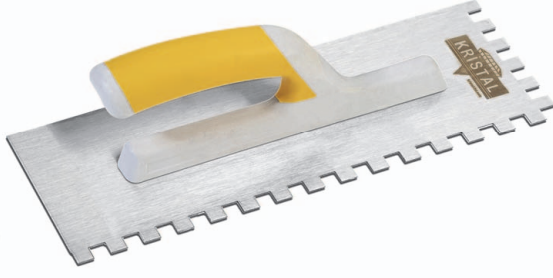

SERAMİK MALASI (Kare Dişli)

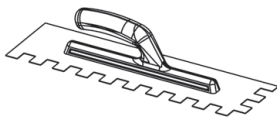
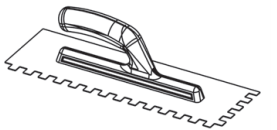
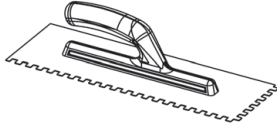
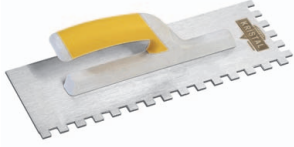
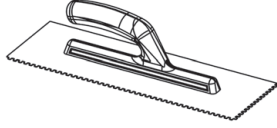
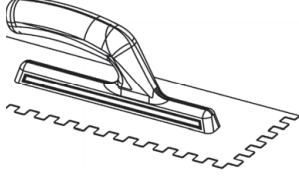

Açık Plastik Saplı

Diş	Ölçü	Ad./Koli	Paslanmaz Çelik		Yay Çeliği	
			Kod	Fiyat/Ad.	Kod	Fiyat/Ad.
4 x 4	30 cm	12	36 535	123,50 ₺	36 135	99,50 ₺
	35 cm	12	36 536	134,50 ₺	36 136	106,20 ₺
	40 cm	12	36 537	146,00 ₺	36 137	114,40 ₺
6 x 6	30 cm	12	36 540	123,50 ₺	36 140	99,50 ₺
	35 cm	12	36 541	134,50 ₺	36 141	106,20 ₺
	40 cm	12	36 542	146,00 ₺	36 142	114,40 ₺
8 x 8	30 cm	12	36 545	123,50 ₺	36 145	99,50 ₺
	35 cm	12	36 546	134,50 ₺	36 146	106,20 ₺
	40 cm	12	36 547	146,00 ₺	36 147	114,40 ₺
10 x 10	30 cm	12	36 550	123,50 ₺	36 150	99,50 ₺
	35 cm	12	36 551	134,50 ₺	36 151	106,20 ₺
	40 cm	12	36 552	146,00 ₺	36 152	114,40 ₺
12 x 12	30 cm	12	36 555	123,50 ₺	36 155	99,50 ₺
	35 cm	12	36 556	134,50 ₺	36 156	106,20 ₺
	40 cm	12	36 557	146,00 ₺	36 157	114,40 ₺
14 x 14	30 cm	12	36 560	123,50 ₺	36 160	99,50 ₺
	35 cm	12	36 561	134,50 ₺	36 161	106,20 ₺
	40 cm	12	36 562	146,00 ₺	36 162	114,40 ₺
16 x 16	30 cm	12	36 565	123,50 ₺	36 165	99,50 ₺
	35 cm	12	36 566	134,50 ₺	36 166	106,20 ₺
	40 cm	12	36 567	146,00 ₺	36 167	114,40 ₺
18 x 18	30 cm	12	36 760	123,50 ₺	36 360	99,50 ₺
	35 cm	12	36 761	134,50 ₺	36 361	106,20 ₺
	40 cm	12	36 762	146,00 ₺	36 362	114,40 ₺
20 x 20	30 cm	12	36 765	123,50 ₺	36 365	99,50 ₺
	35 cm	12	36 766	134,50 ₺	36 366	106,20 ₺
	40 cm	12	36 767	146,00 ₺	36 367	114,40 ₺

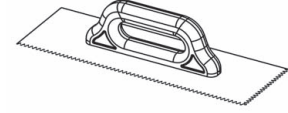

SERAMİK MALASI (Üçgen Dişli)

Kapalı Saplı			Paslanmaz Çelik		Yay Çeliği	
Özellik	Ölçü	Ad./Koli	Kod	Fiyat/Ad.	Kod	Fiyat/Ad.
Plastik Kapalı Saplı	30 cm	12	36 605	130,00 ₺	36 205	102,00 ₺
	35 cm	12	36 606	137,30 ₺	36 206	104,20 ₺
6 mm Üçgen Diş	40 cm	12	36 607	156,00 ₺	36 207	119,00 ₺
	50 cm	12	36 608	195,00 ₺	36 208	142,00 ₺
Plastik Kapalı Saplı	30 cm	12	36 780	130,00 ₺	36 380	102,00 ₺
	35 cm	12	36 781	137,30 ₺	36 381	104,20 ₺
8 mm Üçgen Diş	40 cm	12	36 782	156,00 ₺	36 382	119,00 ₺
	50 cm	12	36 783	195,00 ₺	36 383	142,00 ₺
Plastik Kapalı Saplı	30 cm	12	36 791	130,00 ₺	36391	102,00 ₺
	35 cm	12	36 792	137,30 ₺	36392	104,20 ₺
10 mm Üçgen Diş	40 cm	12	36 793	156,00 ₺	36393	119,00 ₺
	50 cm	13	36 794	195,00 ₺	36394	142,00 ₺
Ahşap Kapalı Saplı	30 cm	12	36 615	161,70 ₺	36 215	120,30 ₺
	35 cm	12	36 616	169,70 ₺	36 216	128,00 ₺
6 mm Üçgen Diş	40 cm	12	36 617	207,80 ₺	36 217	160,20 ₺
	50 cm	12	36 618	254,30 ₺	36 218	188,80 ₺
Ahşap Kapalı Saplı	30 cm	12	36 784	161,70 ₺	36 384	120,30 ₺
	35 cm	12	36 785	169,70 ₺	36 385	128,00 ₺
8 mm Üçgen Diş	40 cm	12	36 786	207,80 ₺	36 386	160,20 ₺
	50 cm	12	36 787	254,30 ₺	36 387	188,80 ₺
Ahşap Kapalı Saplı	30 cm	12	36 795	161,70 ₺	36395	120,30 ₺
	35 cm	12	36 796	169,70 ₺	36396	128,00 ₺
10 mm Üçgen Diş	40 cm	12	36 797	207,80 ₺	36397	160,20 ₺
	50 cm	13	36 798	254,30 ₺	36398	188,80 ₺

Açık Plastik Saplı			Paslanmaz Çelik		Yay Çeliği	
Diş	Ölçü	Ad./Koli	Kod	Fiyat/Ad.	Kod	Fiyat/Ad.
6 mm Üçgen Diş	30 cm	12	36 610	123,50 ₺	36 210	99,50 ₺
	35 cm	12	36 611	134,50 ₺	36 211	106,20 ₺
	40 cm	12	36 612	146,00 ₺	36 212	114,40 ₺
8 mm Üçgen Diş	30 cm	12	36 788	123,50 ₺	36 388	99,50 ₺
	35 cm	12	36 789	134,50 ₺	36 389	106,20 ₺
	40 cm	12	36 790	146,00 ₺	36 390	114,40 ₺
10 mm Üçgen Diş	30 cm	12	36 800	123,50 ₺	36 400	99,50 ₺
	35 cm	12	36 801	134,50 ₺	36 401	106,20 ₺
	40 cm	12	36 802	146,00 ₺	36 402	114,40 ₺

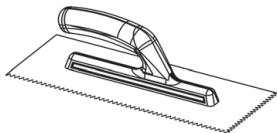

Fiyatlarımız NET' tir.

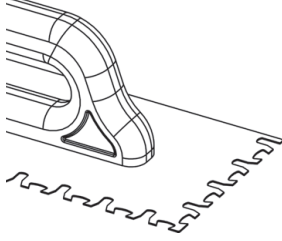

SERAMİK MALASI (Kaplan Dişli)

Kapalı Saplı			Paslanmaz Çelik		Yay Çeliği	
Özellik	Ölçü	Ad./Koli	Kod	Fiyat/Ad.	Kod	Fiyat/Ad.
Plastik Kapalı Saplı	30 cm	12	36 742	130,00 ₺	36 342	102,00 ₺
	35 cm	12	36 743	137,30 ₺	36 343	104,20 ₺
Kapan Diş	40 cm	12	36 744	156,00 ₺	36 344	119,00 ₺
	50 cm	13	36 745	195,00 ₺	36 345	142,00 ₺
Ahşap Kapalı Saplı	30 cm	12	36 738	161,70 ₺	36 338	120,30 ₺
	35 cm	12	36 739	169,70 ₺	36 339	128,00 ₺
Kapan Diş	40 cm	12	36 740	207,80 ₺	36 340	160,20 ₺
	50 cm	13	36 741	254,30 ₺	36 341	188,80 ₺



Açık Plastik Saplı			Paslanmaz Çelik		Yay Çeliği	
Cins	Ölçü	Ad./Koli	Kod	Fiyat/Ad.	Kod	Fiyat/Ad.
Kapan Diş	30 cm	12	36 747	123,50 ₺	36 347	99,50 ₺
Kapan Diş	35 cm	12	36 748	134,50 ₺	36 348	106,20 ₺
Kapan Diş	40 cm	12	36 749	146,00 ₺	36 349	114,40 ₺

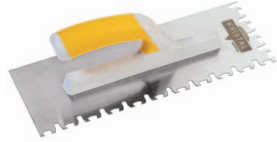

SERAMİK MALASI (U Dişli)

			Paslanmaz Çelik		Yay Çeliği	
Özellik	Ölçü	Ad./Koli	Kod	Fiyat/Ad.	Kod	Fiyat/Ad.
Plastik Kapalı Saplı	30 cm	12	36 714	130,00 ₺	36 314	102,00 ₺
	35 cm	12	36 715	137,30 ₺	36 315	104,20 ₺
	40 cm	12	36 716	156,00 ₺	36 316	119,00 ₺
17 x 20 Diş	50 cm	12	36 717	195,00 ₺	36 317	142,00 ₺
	30 cm	12	36 718	161,70 ₺	36 318	120,30 ₺
Ahşap Kapalı Saplı	35 cm	12	36 719	169,70 ₺	36 319	128,00 ₺
	40 cm	12	36 720	207,80 ₺	36 320	160,20 ₺
17 x 20 Diş	50 cm	12	36 721	254,30 ₺	36 321	188,80 ₺

Açık Plastik Saplı			Paslanmaz Çelik		Yay Çeliği	
Diş	Ölçü	Ad./Koli	Kod	Fiyat/Ad.	Kod	Fiyat/Ad.
17 x 20	30 cm	12	36 722	123,50 ₺	36 322	99,50 ₺
17 x 20	35 cm	12	36 723	134,50 ₺	36 323	106,20 ₺
17 x 20	40 cm	12	36 724	146,00 ₺	36 324	114,40 ₺

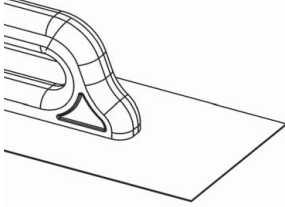
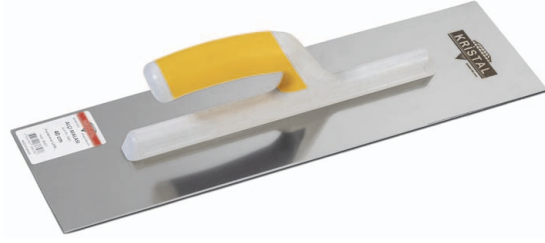

ALÇI MALASI

Kapalı Saplı

Özellik	Ölçü	Ad./Koli	Paslanmaz Çelik		Yay Çeliği	
			Kod	Fiyat/Ad.	Kod	Fiyat/Ad.
Plastik Kapalı Saplı	30 cm	12	36 620	138,50 ₺	36 220	98,80 ₺
	35 cm	12	36 621	145,80 ₺	36 221	102,60 ₺
	40 cm	12	36 622	167,20 ₺	36 222	118,60 ₺
Alçı Malası	50 cm	12	36 623	200,80 ₺	36 223	140,60 ₺
	30 cm	12	36 630	161,70 ₺	36 230	132,30 ₺
Ahşap Kapalı Saplı	35 cm	12	36 631	169,70 ₺	36 231	136,90 ₺
	40 cm	12	36 632	207,80 ₺	36 232	159,00 ₺
Alçı Malası	50 cm	12	36 633	254,30 ₺	36 233	179,00 ₺

Açık Plastik Saplı

Cins	Ölçü	Ad./Koli	Paslanmaz Çelik		Yay Çeliği	
			Kod	Fiyat/Ad.	Kod	Fiyat/Ad.
Dar Tip	8x30 cm	12	36 624	119,00 ₺	36 224	85,80 ₺
Alçı Malası	30 cm	12	36 625	129,80 ₺	36 225	96,10 ₺
Alçı Malası	35 cm	12	36 626	140,70 ₺	36 226	103,90 ₺
Alçı Malası	40 cm	12	36 627	153,00 ₺	36 227	111,80 ₺

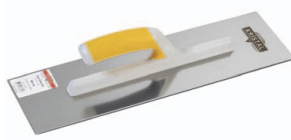

RADÜSLÜ ALÇI MALASI

Kapalı Saplı

Özellik	Ölçü	Ad./Koli	Paslanmaz Çelik		Yay Çeliği	
			Kod	Fiyat/Ad.	Kod	Fiyat/Ad.
Plastik Kapalı Saplı	30 cm	12	36 700	138,50 ₺	36 300	98,80 ₺
	35 cm	12	36 701	145,80 ₺	36 301	102,60 ₺
	40 cm	12	36 702	167,20 ₺	36 302	118,60 ₺
Radüslü Alçı Malası	50 cm	12	36 703	200,80 ₺	36 303	140,60 ₺
	30 cm	12	36 705	161,70 ₺	36 305	132,30 ₺
Ahşap Kapalı Saplı	35 cm	12	36 706	169,70 ₺	36 306	136,90 ₺
	40 cm	12	36 707	207,80 ₺	36 307	159,00 ₺
Radüslü Alçı Malası	50 cm	12	36 708	254,30 ₺	36 308	179,00 ₺

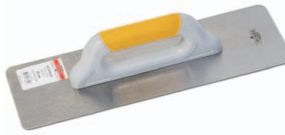
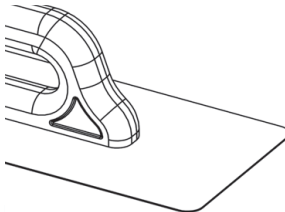

Açık Plastik Saplı

Cins	Ölçü	Ad./Koli	Paslanmaz Çelik		Yay Çeliği	
			Kod	Fiyat/Ad.	Kod	Fiyat/Ad.
Radüslü Alçı M.	30 cm	12	36 710	129,80 ₺	36 310	96,10 ₺
Radüslü Alçı M.	35 cm	12	36 711	140,70 ₺	36 311	103,90 ₺
Radüslü Alçı M.	40 cm	12	36 712	153,00 ₺	36 312	111,80 ₺



Fiyatlarımız NET' tir.

**MERMER MALASI**

Kapalı Saplı			Paslanmaz Çelik		Yay Çeliği	
Özellik	Ölçü	Ad./Koli	Kod	Fiyat/Ad.	Kod	Fiyat/Ad.
Plastik Kapalı Saplı	30 cm	12	36 635	130,00 ₺	36 235	102,00 ₺
	38 cm	12	36 636	156,00 ₺	36 236	117,00 ₺
Mermer M.	49 cm	12	36 637	195,00 ₺	36 237	139,70 ₺
Ahşap Kapalı Saplı	30 cm	12	36 642	161,70 ₺	36 242	120,30 ₺
	38 cm	12	36 643	205,20 ₺	36 243	165,60 ₺
Mermer M.	49 cm	12	36 644	251,80 ₺	36 244	201,70 ₺

Açık Plastik Saplı			Paslanmaz Çelik		Yay Çeliği	
Cins	Ölçü	Ad./Koli	Kod	Fiyat/Ad.	Kod	Fiyat/Ad.
Mermer M.	30 cm	12	36 640	123,50 ₺	36 240	99,50 ₺
Mermer M.	38 cm	12	36 641	140,90 ₺	36 241	103,70 ₺

ŞAP MALASI

Açık Plastik Saplı			Yay Çeliği			
Cins	Ölçü	Ad./Koli	Kod	Fiyat/Ad.	Kod	Fiyat/Ad.
Şap Malası	55 cm	12	36 245	153,00 ₺		
Şap Malası	65 cm	12	36 246	169,70 ₺		

MANTOLAMA MALASI

Açık Plastik Saplı			Paslanmaz Çelik		Yay Çeliği	
Cins	Ölçü	Ad./Koli	Kod	Fiyat/Ad.	Kod	Fiyat/Ad.
Mantolama	35 cm	12	36 647	134,50 ₺	36 247	106,20 ₺

MARLEY MALASI

Açık Plastik Saplı			Paslanmaz Çelik		Yay Çeliği	
Cins	Ölçü	Ad./Koli	Kod	Fiyat/Ad.	Kod	Fiyat/Ad.
Marley M.	30 cm	12	36 649	123,50 ₺	36 249	99,50 ₺

HAVUZ MALASI

Açık Plastik Saplı			Paslanmaz Çelik		Yay Çeliği	
Cins	Ölçü	Ad./Koli	Kod	Fiyat/Ad.	Kod	Fiyat/Ad.
Havuz M.	45 cm	12	36 650	169,40 ₺	36 250	129,90 ₺

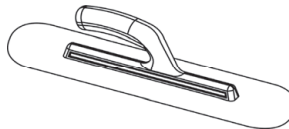

OTO İSPATULA

Kalınlık: 0,35 mm



Plastik Saplı

Cins	Ad./Pk.	Paslanmaz Çelik		Yay Çeliği	
		Kod	Fiyat/Ad.	Kod	Fiyat/Ad.
4'lü Set	1 tkm	36 696	67,00 ₺	36 296	57,80 ₺

Set içi; 5cm, 8cm, 10cm, 12cm enlerinde, 12cm uzunluğundadır.

OTO MACUN ÇELİĞİ

Kalınlık: 0,35 mm

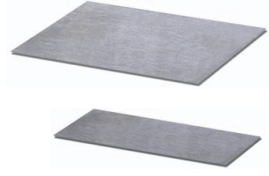

Cins	Ad./Pk.	Paslanmaz Çelik		Yay Çeliği	
		Kod	Fiyat/Pk.	Kod	Fiyat/Pk.
12x16 cm	2	36 697	32,50 ₺	36 297	21,10 ₺
12x25 cm	2	36 698	45,50 ₺	36 298	26,00 ₺
SİSTRE 6x12 cm	6	36 699	25,90 ₺	36 299	18,90 ₺



KAZIMA RASPASI

Cins	Ad./Pk.	Kod	Fiyat/Ad.
10 cm	12	36 251	88,20 ₺

İSPATULA

Ahşap Saplı

Cins	Pk./Ad.	Paslanmaz Çelik		Yay Çeliği	
		Kod	Fiyat/Ad.	Kod	Fiyat/Ad.
6 cm	24	36 655	72,80 ₺	36 255	66,80 ₺
7 cm	24	36 654	74,70 ₺	36 254	68,70 ₺
8 cm	24	36 656	76,70 ₺	36 256	70,40 ₺
9 cm	24	36 657	82,50 ₺	36 257	72,90 ₺
10 cm	24	36 658	85,10 ₺	36 258	74,10 ₺
11 cm	24	36 659	88,40 ₺	36 259	75,10 ₺
12 cm	24	36 660	94,20 ₺	36 260	80,90 ₺
14 cm	24	36 661	98,10 ₺	36 261	84,50 ₺
16 cm	24	36 662	100,70 ₺	36 262	90,30 ₺
18 cm	24	36 663	105,30 ₺	36 263	93,20 ₺



PROFESYONEL MACUN İSPATULASI



Cins	Pk./Ad.	Paslanmaz Çelik	
		Kod	Fiyat/Ad.
6 cm	10	36 030	55,00 ₺
8 cm	10	36 031	56,00 ₺
10 cm	10	36 032	58,80 ₺
12 cm	10	36 033	65,80 ₺
15 cm	10	36 034	81,00 ₺

Fiyatlarımız NET' tir.



GENİŞ İSPATULA



Ahşap Saplı		Paslanmaz Çelik		Yay Çeliği	
Cins	Pk./Ad.	Kod	Fiyat/Ad.	Kod	Fiyat/Ad.
10 x 17 cm	14	36 673	95,90 ₺	36 273	75,00 ₺
10 x 22 cm	14	36 674	101,90 ₺	36 274	79,00 ₺

MACUN KÜREĞİ



Ahşap Saplı		Yay Çeliği	
Cins	Pk./Ad.	Kod	Fiyat/Ad.
18 x 18 cm	12	36 277	119,10 ₺
20 x 20 cm	12	36 278	122,80 ₺

MACUN KÜREĞİ, Kısa Model



Ahşap Saplı		Yay Çeliği	
Cins	Pk./Ad.	Kod	Fiyat/Ad.
11 x 18 cm	12	36 280	115,80 ₺
11 x 20 cm	12	36 281	118,80 ₺

FAYANS TARAĞI

ölçü: 8 x 17 cm



Ahşap Saplı		Paslanmaz Çelik		Yay Çeliği	
Diş (mm)	Pk./Ad.	Kod	Fiyat/Ad.	Kod	Fiyat/Ad.
4 x 4	8	36 690	102,90 ₺	36 290	81,30 ₺
6 x 6	8	36 691	102,90 ₺	36 291	81,30 ₺
8 x 8	8	36 692	102,90 ₺	36 292	81,30 ₺
10 x 10	8	36 693	102,90 ₺	36 293	81,30 ₺
12 x 12	8	36 694	102,90 ₺	36 294	81,30 ₺
Üçgen (6mm)	8	36 695	102,90 ₺	36 295	81,30 ₺

EKLEM MALASI



Yay Çeliği		Ahşap Saplı	
Ölçü	Pk./Ad.	Kod	Fiyat/Ad.
175 mm	12	36 916	80,00 ₺

SIVA MALASI

Yay Çeliği

Ahşap Saplı

Ölçü	Pk./Ad.	Kod	Fiyat/Ad.
14 cm	12	36 900	79,70 ₺
16 cm	12	36 901	82,30 ₺
18 cm	12	36 902	85,50 ₺
20 cm	12	36 903	86,90 ₺
22 cm	12	36 904	93,00 ₺
24 cm	12	36 905	97,20 ₺
26 cm	12	36 906	100,60 ₺



DİL MALASI

Yay Çeliği

Ahşap Saplı

Ölçü	Pk./Ad.	Kod	Fiyat/Ad.
13 cm	12	36 908	94,20 ₺
16 cm	12	36 909	97,50 ₺
18 cm	12	36 910	101,40 ₺
20 cm	12	36 911	104,00 ₺



TAMİR MALASI

Yay Çeliği

Ahşap Saplı

Ölçü	Pk./Ad.	Kod	Fiyat/Ad.
14 cm	12	36 913	85,80 ₺



GAZBETON MALASI

Yay Çeliği

Ahşap Saplı

Ölçü	Pk./Ad.	Kod	Fiyat/Ad.
22 cm	12	36 915	100,00 ₺



DUVARCI MALASI

Yay Çeliği

Ahşap Saplı

Ölçü	Pk./Ad.	Kod	Fiyat/Ad.
14 cm	12	36 920	93,00 ₺
16 cm	12	36 921	99,00 ₺
18 cm	12	36 922	105,00 ₺
20 cm	12	36 923	111,00 ₺
22 cm	12	36 924	117,00 ₺

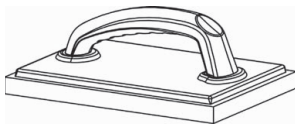
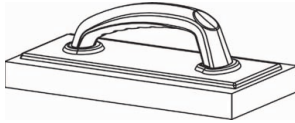
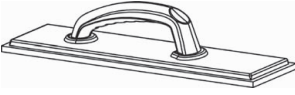
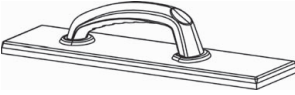

Fiyatlarımız NET'tir.

**TİRFİL MALA**

Cins	Ad./Pk.	Kod	Fiyat/Ad.
Kısa 150 x 225 mm	12	36 015	93,00 ₺
Uzun 100 x 370 mm	12	36 016	98,00 ₺

DERZ MALASI

Cins	Ad./Pk.	Kod	Fiyat/Ad.
Kısa 115 x 280 mm	12	36 020	88,00 ₺
Uzun 115 x 385 mm	12	36 021	97,00 ₺

SÜNGERLİ MALA

Cins	Ad./Pk.	Kod	Fiyat/Ad.
140 x 280 mm	12	36 017	96,00 ₺
160 x 300 mm	12	36 018	105,00 ₺

SERAMİKÇİ SÜNGERİ

Ölçü	Ad./Pk.	Kod	Fiyat/Ad.
70 x 120 x 160 mm	12	36 023	25,00 ₺

KAUÇUKLU MALA

Cins	Ad./Pk.	Kod	Fiyat/Ad.
140 x 280 mm	12	36 024	150,00 ₺
165 x 240 mm	12	36 026	150,00 ₺
140 x 280 mm Küçük Gözenekli	12	36 028	

KALETERASİT MALASI (kapalı saplı)

Ölçü	Ad./Pk.	Kod	Fiyat/Ad.
125 x 300 mm	16	36 019	53,10 ₺

EPOKSİ DERZ MALASI



Ölçü	Ad./Pk.	Kod	Fiyat/Ad.
115 x 280 mm Mala	12	36 055	150,00 ₺
Sert Yedek Elastomer	12	36 056	66,70 ₺

EPOKSİ ZİMPARA MALASI



Ölçü	Ad./Pk.	Kod	Fiyat/Ad.
125 x 300 mm Mala	12	36 058	165,00 ₺
Scotch Büyük Gözenekli	12	36 059	42,10 ₺
Scotch Orta Gözenekli	12	36 060	33,30 ₺

ZİMPARA MALASI (90x300 mm)



Cins	Ad./Pk.	Kod	Fiyat/Ad.
Zımpara Malası	12	36 061	71,00 ₺
Oynar Başlı	12	36 062	68,00 ₺

CIRTLI ZİMPARA MALASI



Ölçü	Ad./Pk.	Kod	Fiyat/Ad.
125 x 300 mm	12	36 069	124,20 ₺
Velcro Zımpara 125 x 300 mm	100	Cırtlı	17,00 ₺
60 kum kod: 36 065	120 kum kod: 36 066	180 kum kod: 36 067	220 kum kod: 36 068

DERZ TEMİZLEYİCİ



Ölçü	Ad./Pk.	Kod	Fiyat/Ad.
200 mm	10	36 037	44,00 ₺
250 mm	10	36 038	52,00 ₺

EPOKSİ DERZ TEMİZLEYİCİ



Ölçü	Ad./Pk.	Kod	Fiyat/Ad.
145 mm	10	36 052	60,00 ₺
245 mm	10	36 053	70,00 ₺

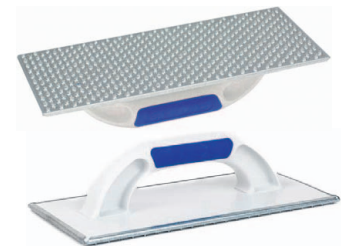

DUVAR RASPASI

Ölçü	Ad./Pk.	Kod	Fiyat/Ad.
130 x 270 mm	20	36 054	157,50 ₺

Fiyatlarımız NET'tir.

**ELASTİK KOVA**

Cins	Ad./Pk.	Kod	Fiyat/Ad.
15 litre	10	36 050	73,00 ₺
26 litre	10	36 049	100,00 ₺
42 litre	10	36 048	120,00 ₺

**HARÇ KOVASI**

Cins	Ad./Pk.	Kod	Fiyat/Ad.
11 litre	10	36 047	109,90 ₺

**SIVA VE ALÇI TEKNESİ**

Cins	Ad./Pk.	Kod	Fiyat/Ad.
35 litre	1	36 046	210,00 ₺

**BOYACI KOVASI**

Cins	Ad./Pk.	Kod	Fiyat/Ad.
14 litre	1	36 045	100,00 ₺

**SERAMİK DÖSEME KOVASI**

Cins	Ad./Pk.	Kod	Fiyat/Ad.
24 litre	1	36 040	553,00 ₺

**POLİÜRETAN DİZLİK**

Cins	Ad./Pk.	Kod	Fiyat/Çift
Poliüretan Dizlik	20	334 48	7,80 €

**KAUÇUK TOKMAK (Beyaz & Ahşap Saplı)**

Cins	Ad./Pk.	Kod	Fiyat/Ad.
500 gr	36	334 45	3,20 \$
750 gr	24	334 46	4,00 \$
1000 gr	24	334 47	4,90 \$

GAZBETON KÜREĞİ

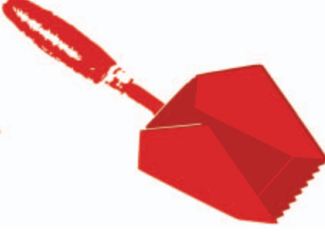

Cins	Ad./Pk.	Kod	Fiyat/Ad.
8,5 cm	2	212 15	
10,5 cm	2	212 16	
13,5 cm	2	212 17	
15,5 cm	2	212 18	
20,5 cm	2	212 19	
25,5 cm	2	212 20	

GAZBETON GÖNYESİ

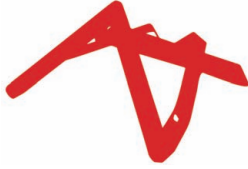

Cins	Ad./Pk.	Kod	Fiyat/Ad.
26 cm	6	212 22	

GAZBETON KANAL AÇICI



Cins	Ad./Pk.	Kod	Fiyat/Ad.
45 cm	6	212 23	

GAZBETON ELEKTRİK BUAT AÇICI



Cins	Ad./Pk.	Kod	Fiyat/Ad.
12,5 cm	12	212 26	

GAZBETON ASPİRATÖR BACA PANÇI



Cins	Ad./Pk.	Kod	Fiyat/Ad.
36 cm	6	212 27	

GAZBETON KOMBİ BACA PANÇI



Cins	Ad./Pk.	Kod	Fiyat/Ad.
36 cm	6	212 28	

Fiyatlarımız NET' tir.

**İSPATULA****Açık Plastik Saplı**

Cins	Ad./Pk.	Kod	Fiyat/Ad. *
6 cm	12	36 265	24,00 ₺
8 cm	12	36 266	25,30 ₺
10 cm	12	36 267	29,30 ₺
12 cm	12	36 268	32,00 ₺
14 cm	12	36 269	33,30 ₺
18 cm	12	36 271	38,00 ₺

**MACUN KÜREĞİ****Plastik Saplı**

Cins	Ad./Pk.	Kod	Fiyat/Ad. *
18 cm	12	36 286	62,70 ₺
20 cm	12	36 287	69,30 ₺

**SIVACI KÜREĞİ**

Cins	Ad./Pk.	Kod	Fiyat/Ad. *
Sivacı Küreği	12	36 010	82,70 ₺ *

**SERPME KÜREĞİ**

Cins	Ad./Pk.	Kod	Fiyat/Ad. *
Serpme Küreği	12	36 012	33,30 ₺ *

**KALETERASİT MALASI**

Cins	Ad./Pk.	Kod	Fiyat/Ad. *
Kaleterasit Malası	12	36 027	48,00 ₺ *

**PROFESYONEL SU ATMA FIRÇASI**

Cins	Ad./Pk.	Kod	Fiyat/Ad. *
Su Atma Fırçası	12	76 271	56,00 ₺ *

**KALIN ÖRTÜ**

Kod	Ad./Pk.	m2	Fiyat/Ad. *
76 200	20	10	16,70 ₺
76 201	20	20	
76 202	20	32	
76 203	12	50	49,20 ₺



RULO ELEĞİ

Kod	Cins	Ad./Pk.	Fiyat/Ad.
36 013	Rulo Eleği	12	12,70 ₺ *



PARMAK RULO TAKIM (sırk takılabilir sap)

Kod	Cins	Ad./Pk.	Fiyat/Ad.
76 251	10 cm	50	18,00 ₺

İç dış cephe, metal ve ahşap boya uygulamalarında kullanıma uygundur.



RULO TAKIM (sırk takılabilir sap)

Kod	Cins	Ad./Pk.	Fiyat/Ad.
76 252	20 cm	25	42,70 ₺
76 253	25 cm	25	45,30 ₺

İç ve dış cephe boya uygulamalarında kullanıma uygundur.



SATEN RULO TAKIM (sırk takılabilir sap)

Kod	Cins	Ad./Pk.	Fiyat/Ad.
76 255	20 cm	25	42,70 ₺
76 256	25 cm	25	45,30 ₺

İç cephe boya uygulamalarında kullanıma uygundur.

RULO YEDEKLERİ



Kod	Cins	Kullanım	Ad./Pk.	Fiyat/Ad.
76 260	5 cm	İç-dış cephe	15	5,20 ₺
76 261	10 cm	İç-dış cephe	10	5,20 ₺
76 262	20 cm	İç-dış cephe	10	32,00 ₺
76 263	25 cm	İç-dış cephe	10	34,70 ₺
76 264	20 cm	İç cephe	10	32,00 ₺
76 265	25 cm	İç cephe	10	34,70 ₺

%100 Polyamid' den üretilmiştir. Dalgalanma yapmaz.

RULO SAPI



Kod	Cins	Ad./Pk.	Fiyat/Ad.
76 266	5 cm	50	8,70 ₺
76 267	10 cm	50	10,00 ₺
76 268	20 cm	25	14,70 ₺
76 269	25 cm	25	16,00 ₺

Özel sırk takılabilir sap tasarımı.

NOT



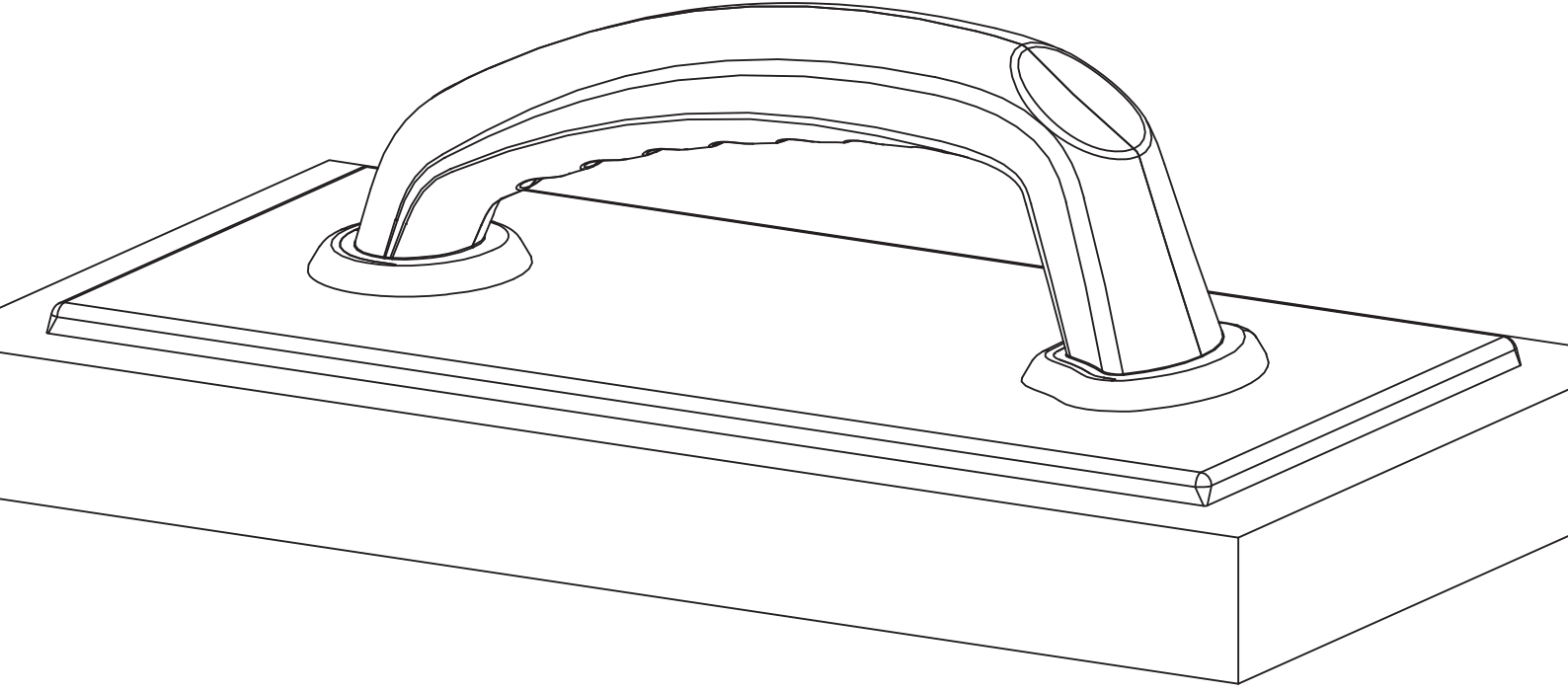

ER-MO NALBURIYE SAN. VE TİC. LTD. ŞTİ.
İTOB OSB. 10001 Sk. No:11 Menderes - İzmir / Türkiye
Tel: **+90 232 375 5415** • Fax: **+90 232 375 5392**
bilgi@ermo.com.tr • siparis@ermo.com.tr
www.ermo.com.tr



ISO 9001
QUALITY MANAGEMENT SYSTEM
CERTIFIED BY SZUTEST